



CONTRACT COLLECTION 2024

Entre EXPERT, *on se comprend...*

Expert des matières et du design depuis 60 ans, Grosfillex a toujours mis son savoir-faire au service d'autres experts, vous, les professionnels du monde entier. Bâtiment, Hôtellerie, Restauration, Stades, Collectivités, Architecture d'intérieur...

Ces marchés experts représentent 50 % de notre activité.

Nous savons bien que la première chose que vous attendez d'un partenaire, c'est l'excellence, sur la qualité des produits comme sur la fiabilité des services. Une valeur ajoutée que nous avons à cœur de vous offrir depuis toujours et qui s'exprime dans la richesse de notre gamme de mobilier, dans la durabilité de nos produits, dans la technicité innovante de nos matériaux, la disponibilité de notre stock mais aussi dans l'engagement de nos équipes. Dans un monde qui change de plus en plus vite, nous restons plus que jamais à l'avant-garde, en défendant des valeurs qui sont aussi les vôtres : la fabrication et la création françaises, le respect de l'environnement, la qualité de la relation, la réactivité et surtout la souplesse, qui nous donne la capacité d'être le complice de votre quotidien !

Tra ESPERTI *ci si capisce...*

Esperta di materiali e design da 60 anni, Grosfillex ha sempre messo il suo savoir-faire al servizio di altri esperti, voi professionisti di tutto il mondo. Edilizia, settore alberghiero, ristorazione, stadi, settore pubblico, architettura d'interni... Questi mercati professionali rappresentano il 50% della nostra attività. Sappiamo bene che vi aspettate l'eccellenza dai vostri partner, sia nella qualità dei prodotti sia nell'affidabilità dei servizi. Un valore aggiunto che da sempre ci teniamo a offrirvi e che si esprime nella ricchezza della nostra gamma di mobili, nella durezza dei nostri prodotti, nell'innovativa tecnica dei nostri materiali, nella disponibilità dei nostri stock ma anche nell'impegno delle nostre squadre. Rimaniamo sempre all'avanguardia in un mondo che cambia sempre più velocemente, difendendo i valori che condividete con noi: la produzione e la creazione francese, il rispetto dell'ambiente, la qualità dei rapporti, la reattività e soprattutto la flessibilità che ci permette di partecipare alla vostra quotidianità.

Unter EXPERTEN *versteht man sich...*

Grosfillex ist seit 60 Jahren Experte in Material und Design und hat sein Fachwissen immer auch anderen Experten, wie Ihnen, Fachleuten aus der ganzen Welt zur Verfügung gestellt. Bauwesen, Hotellerie, Gastronomie, Stadien, öffentliche Gebäude, Innenarchitektur...

Der gewerbliche Bereich repräsentiert 50% unserer Aktivitäten.

Wir wissen genau, dass das erste, was Sie von einem Partner erwarten, eine einwandfreie Qualität der Produkte sowie zuverlässige Dienstleistungen sind. Ein Mehrwert, den wir Ihnen unbedingt bieten möchten und der sich in der Vielfalt unseres Möbel, in der Nachhaltigkeit unserer Produkte, in der innovativen Fachlichkeit unserer Werkstoffe, in der Verfügbarkeit unseres Bestands wie auch im Engagement unserer Teams ausdrückt.

In einer sich immer schneller verändernden Welt bleiben wir mehr denn je in der ersten Reihe, indem wir unsere Werte verteidigen: die französische Herstellung und Kreation, der Umweltschutz, die Qualität der Beziehung, die Reaktionsfreudigkeit und vor allem die Flexibilität, die uns ermöglicht, Sie täglich zu betreuen!



MOBILIER - ARREDI - MÖBEL

BAC - VASI - PFLANZENGEFÄSSE



REVÊTEMENT - RIVESTIMENTI - VERKLEIDUNGEN

FENÊTRES - FINESTRE - FENSTER



SIÈGES DE STADE - SEDUTE DA STADIO - SITZE FÜR STADION

GROSFILLEX *groupe*

beaucoup plus que du mobilier

Fondée par Auguste, François et Jean Grosfillex en 1927 en France, à Oyonnax au cœur de la région Rhône-Alpes, l'entreprise a d'abord été spécialisée en tournerie sur bois. En 2021, près d'un siècle plus tard, nous sommes restés un groupe familial indépendant, qui travaille la résine, le métal et de nombreux matériaux composites dans des mix de matières raffinés, pour différents marchés dans le monde entier.

Mobilier outdoor, revêtements murs et plafonds, menuiserie, abri de jardin...

Devenue une référence internationale sur le marché du mobilier, Grosfillex a réussi à concilier ambitions, innovation et imagination en diversifiant ses activités. Des revêtements muraux au carrelage composite, des bains de soleil aux tables et aux menuiseries, nous nous appuyons sur notre expertise matière pour évoluer, nous adapter et donner forme à la qualité de vie.

GROSFILLEX *gruppo*

molto più che dei mobili

Fondata nel 1927 da Auguste, François e Jean Grosfillex a Oyonnax (Francia), nel cuore della regione Rodano-Alpi, l'azienda è stata inizialmente specializzata nella torneria del legno. Quasi un secolo dopo, nel 2021, siamo ancora un gruppo familiare indipendente che lavora la resina, il metallo e numerosi materiali compositi nei mix di materiali raffinati adatti a diversi mercati in tutto il mondo.

Mobili per esterni, rivestimenti murali e per soffitti, serramenti, cassette, ecc.

Diventata un punto di riferimento internazionale del mercato dell'arredamento, Grosfillex ha saputo associare ambizione, innovazione e immaginazione diversificando le sue attività. Dai rivestimenti murali alle piastrelle composite, dalle sdraio ai tavoli e ai serramenti, facciamo leva sulla nostra esperienza nel settore per evolvere, adattarci e dare forma alla qualità della vita.

GROSFILLEX *gruppe*

mehr als nur Möbel

Das Unternehmen wurde 1927 von Auguste, François und Jean Grosfillex im französischen Oyonnax gegründet, das mitten in der Region Rhône-Alpes liegt. Anfangs war es auf Holzdreherei spezialisiert. 2021, also knapp ein Jahrhundert später, sind wir immer noch ein unabhängiges Familienunternehmen, das Kunstharz, Metall und zahlreiche Verbundwerkstoffe in raffinierten Materialmischungen für verschiedenste Märkte weltweit verarbeitet.

Outdoor-Mobiliar, Wand- und Deckenverkleidungen, Fenster, Gartenhäuser...

Grosfillex ist heute noch immer eine internationale Referenz auf dem Möbelmarkt und dem Unternehmen ist es gelungen, Ambitionen, Innovation und Vorstellungskraft zu vereinen und seine Tätigkeiten zu diversifizieren. Von Wandverkleidungen bis zu Kompositfliesen, von Sonnenliegen bis zu Tischen und dem Fensterrahmen, wir verlassen uns auf unser Fachwissen, um uns weiterzuentwickeln, uns anzupassen und der Lebensqualität eine Form zu geben.

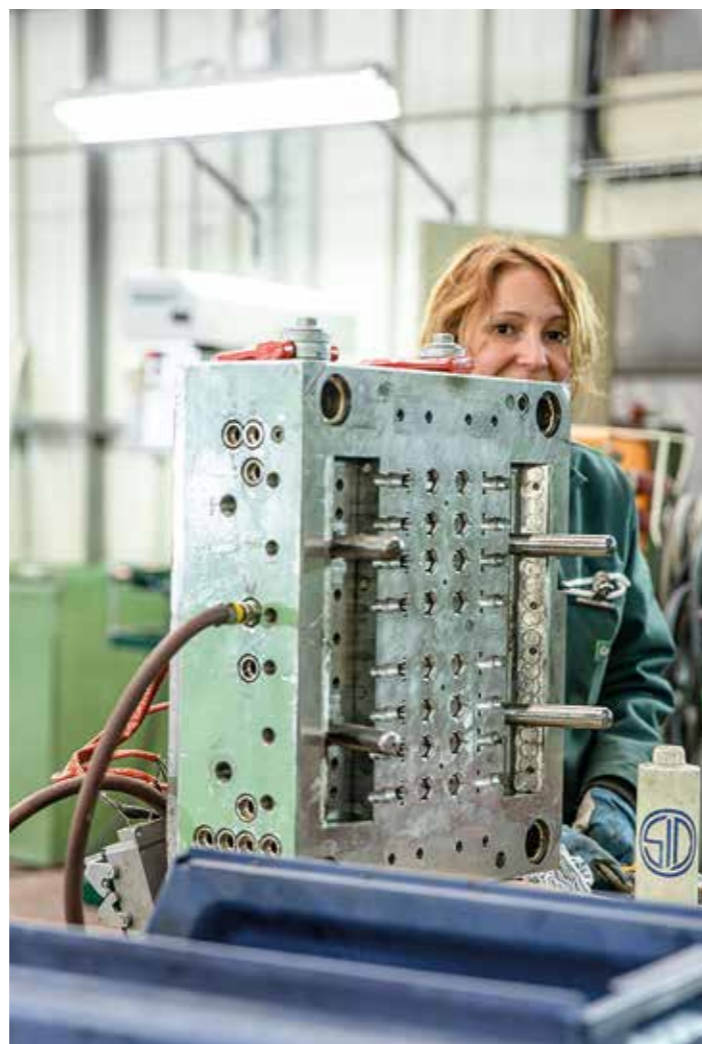

GROSFILLEX *expertise*

beaucoup plus que de la résine

Mondialement connu pour son expertise de la résine, Grosfillex sait en exploiter les immenses possibilités, en termes de formes, de textures et de couleurs, et même en inventer d'autres... Tout en garantissant une parfaite tenue et durabilité, quelles que soient les conditions d'utilisation.

Transformation & ennoblissement des matériaux

Compoundage, extrusion, injection, soufflage, injection gaz, impression... La maîtrise en interne d'une large palette de process technologiques nous a ouvert de nouvelles perspectives. Nous avons ainsi développé des matériaux composites innovants, où la résine est associée à d'autres composants comme la fibre de verre ou des paillettes, parfois sublimée par des effets de relief ou des impressions numériques. Résultat, du métal, du marbre, du béton ou du bois plus vrais que nature, avec les bénéfiques techniques de la résine en plus. Garder tout le potentiel esthétique d'un matériau en supprimant ses inconvénients, voilà l'ambition de notre travail d'ennoblissement de la matière. Un terrain de jeu infini pour nos designers, des atouts en plus pour vous...

GROSFILLEX *esperienza*

molto più che della resina

Famosa in tutto il mondo per la sua esperienza nella resina, Grosfillex ne sa sfruttare le immense potenzialità in termini di forma, texture e colori e sa pure inventarne altre... Il tutto garantendo una perfetta resistenza e durevolezza, indipendentemente dalle condizioni di utilizzo.

Trasformazione e nobilitazione dei materiali

Compounding, estrusione, iniezione, soffiatura, iniezione a gas, stampa... Il saper padroneggiare in azienda un'ampia gamma di processi tecnologici ci ha aperto nuove prospettive. Abbiamo quindi sviluppato innovativi materiali compositi, nei quali la resina è associata ad altri componenti come la fibra di vetro o le paillette, talvolta sublimati da effetti a rilievo o stampe digitali. Risultato: metallo, marmo, cemento o legno assolutamente realistici, con in più i pregi tecnici della resina. L'ambizione del nostro lavoro di nobilitazione dei materiali è di conservare tutto il potenziale estetico di un materiale, eliminandone i difetti. Un campo da gioco infinito per i nostri designer e tanti vantaggi supplementari per voi.

GROSFILLEX *expertise*

viel mehr als Kunststoff

Grosfillex genießt einen internationalen Bekanntheitsgrad für sein Fachwissen über Kunststoff und weiß, die unzähligen Möglichkeiten in Bezug auf Formen, Texturen und Farben zu nutzen und sogar neue zu erfinden... Gleichzeitig werden bei allen Nutzungsbedingungen optimaler Halt und Nachhaltigkeit garantiert.

Verarbeitung & Veredelung von Werkstoffen

Compounding, Extrusion, Injektion, Blasverfahren, Gasinjektion, Druck... Die Beherrschung einer breiten Palette technologischer Verfahren innerhalb des Unternehmens hat uns neue Perspektiven eröffnet. Auf diese Weise haben wir neue Verbundwerkstoffe entwickelt, bei denen Harz mit anderen Komponenten wie Glasfaser oder Partikeln verbunden, und manchmal durch Reliefeffekte oder digitale Drucke sublimiert wird. Das Ergebnis: Der Effekt von Metall, Marmor, Beton oder Holz, naturgetreu mit den technischen Vorteilen von Kunstharz. Das ästhetische Potential eines Werkstoffs beibehalten und dabei seine Nachteile beseitigen: das ist die Ambition unserer Veredelungsarbeit des Werkstoffs. Ein endloses Spielfeld für unsere Designer, zusätzliche Vorteile für Sie...



GROSFILLEX *inspiration*

beaucoup plus que du design

Parfois enrichi par des collaborations avec des créateurs externes, le design a toujours été intégré dans l'entreprise, car notre défi ultime est de trouver la parfaite harmonie entre le fond et la forme, entre le design et la matière. Notre Studio de Design travaille donc main dans la main avec notre Bureau d'Études. Inspirées de matériaux traditionnels, nos nouvelles résines vont au-delà de la matière, en déclinant les codes de chaque matière de référence, dans les formes, les formats, le poids ou le design.

GROSFILLEX *ispirazione*

molto più che design

Il design, talvolta arricchito da collaborazioni con creatori esterni, è sempre stato un elemento centrale dell'azienda in quanto il nostro obiettivo è di trovare la perfetta armonia tra il fondo e la forma, tra il design e la materia. Il nostro Studio di design collabora con il nostro Ufficio progetti. Ispirate a materiali tradizionali, le nuove resine vanno oltre la materia assumendo le caratteristiche di ogni materiale di riferimento nelle forme, nei formati, nel peso o nel design.

GROSFILLEX *inspiration*

mehr als nur design

Design war schon immer ein wesentlicher Bestandteil in unserem Unternehmen, teils auch bereichert durch die Zusammenarbeit mit externen Designern. Unsere ultimative Herausforderung besteht darin, die perfekte Harmonie zwischen Funktion und Form, zwischen Design und Material zu finden. Unser Designstudio arbeitet Hand in Hand mit unserem Entwicklungsbüro. Inspiriert von traditionellen Materialien, denken wir unser Material über den Werkstoff hinaus, deklinieren neue codes für Referenz Materialien, in Form, Format, Gewicht und Design.



GROSFILLEX *excellence*

beaucoup plus que les normes

Depuis toujours, la qualité est au cœur des valeurs de marque Grosfillex. Certifiée ISO 9001 pour la conception, la fabrication et la vente d'équipements réalisés à base de matières plastiques, l'entreprise garde la maîtrise totale de son compoundage et de toutes les étapes du process de production. Présents dans 80 pays, nos produits répondent aux normes internationales de sécurité les plus exigeantes, notamment américaines, et sont certifiés par des laboratoires indépendants agréés. Tous sont systématiquement éprouvés par notre laboratoire interne en amont, qui les soumet à des tests encore plus impitoyables que les normes en vigueur.

GROSFILLEX *eccellenza*

molto più che degli standard

La qualità è da sempre uno dei valori fondamentali di Grosfillex. Certificata ISO 9001 per la progettazione, produzione e vendita di attrezzature realizzate con materiali plastici, l'azienda mantiene la gestione totale del suo compounding e di tutte le fasi del processo di produzione. Presenti in 80 paesi, i nostri prodotti rispondono alle più rigide normative internazionali di sicurezza, in particolare quelle americane, e sono certificati da laboratori autorizzati indipendenti. E prima di ciò, sono tutti sistematicamente messi alla prova dal nostro laboratorio interno, che li sottopone a test ancora più rigidi rispetto alle normative in vigore.

GROSFILLEX *vortrefflichkeit*

viel mehr als normen

Grosfillex Exzellenz – viel mehr als die Norm Qualität steht seit jeher im Mittelpunkt der Marke Grosfillex. Das Unternehmen ist ISO 9001 zertifiziert in den Bereichen Konzept, Herstellung, Vertrieb von Ausrüstungen aus Kunststoffen und kontrolliert sein Compounding und sämtliche Schritte im Produktionsprozeß. Präsent in über 80 Ländern weltweit, erfüllen unsere Produkte höchste internationale Sicherheitsnormen, auch die besonders anspruchsvollen amerikanischen Normen. Die Produkte werden durch unabhängige Institute zertifiziert. Im Vorfeld werden unsere Produkte systematisch im eigenen Labor geprüft, unter Bedingungen, die härter sind als die geltenden Normen.

GROSFILLEX France

beaucoup plus qu'un symbole

Créée en France à Oyonnax, Grosfillex est fière de son enracinement dans la Plastic Valley de l'Ain. Plus qu'une tradition d'expertise, la plasturgie est ici une filière d'excellence, connectée sur le futur et sur les nouvelles attentes des marchés.

Géographiquement au centre de l'Europe, Grosfillex cultive une grande proximité avec ses clients. Cette situation stratégique permet aussi d'optimiser le transport et fait écho à nos engagements environnementaux.

Plus que jamais, Rhône-Alpes reste un haut lieu de l'industrie et de la créativité à la française et pour faire honneur à cet ancrage local, toutes les photos des produits que vous allez découvrir ont été réalisées dans notre région.

GROSFILLEX Francia

molto più che un simbolo

Creata a Oyonnax (Francia), Grosfillex è fiera del suo radicamento nella Plastic Valley dell'Ain. Qui la plasturgia è molto più che tramandarsi l'esperienza: è una filiera d'eccellenza, connessa con il futuro e orientata verso le nuove aspettative dei mercati.

Geograficamente sita al centro dell'Europa, Grosfillex coltiva le relazioni con i suoi clienti. Questa situazione strategica ci permette inoltre di ottimizzare i trasporti e rispetta i nostri impegni a livello ambientale.

Il Rodano-Alpi resta una roccaforte dell'industria e della creatività alla francese e, per onorare questo radicamento nel territorio, tutte le foto dei prodotti sono state realizzate nella nostra regione.

GROSFILLEX Frankreich

viel mehr als ein symbol

Grosfillex wurde im französischen Oyonnax gegründet und ist stolz auf seine Verwurzelung im Plastic Valley im Département Ain. Die Kunststoffverarbeitung ist hier mehr als nur eine fachmännische Tradition, sie ist eine Branche der Vortrefflichkeit, verbunden mit der Zukunft und mit den neuen Erwartungen im Markt.

Geografisch gesehen befindet sich Grosfillex in der Mitte Europas und legt großen Wert darauf, in der Nähe seiner Kunden zu sein. Dieser strategische Standort ermöglicht auch einen optimalen Transport und knüpft an unsere umweltbedingten Engagements an.

Mehr denn je bleibt die Region Rhône-Alpes eine Hochburg der Industrie und der Kreativität im französischen Stil und um diese lokale Verankerung hervorzuheben, wurden alle Fotos der Produkte, die Sie sehen werden, in unserer Region aufgenommen.

La responsabilité sociétale de GROSFILLEX

Acteur majeur dans la conception et la fabrication d'équipements pour l'habitat à base de matières plastiques, Grosfillex s'est engagé depuis plusieurs années dans une démarche de progrès visant à réduire les impacts environnementaux de son activité au travers de 4 champs d'action privilégiés :

ENVIRONNEMENT :

- Des matériaux durables et recyclables pour une grande longévité
- Economie circulaire et utilisation de matière recyclée dans de nouveaux produits
- Recyclabilité des matières : 100% des chutes issues de nos chaînes de production sont triées, broyées et régénérées
- Maîtrise des énergies : obtention de la certification ISO 50 001 en 2022

RELATIONS & CONDITIONS DE TRAVAIL :

- Un climat de travail de qualité ; sécurité avant tout

LOYAUTÉ ET ACHATS RESPONSABLES :

- Une fabrication française responsable dans tout son écosystème

EMPREINTE LOCALE :

- Une marque familiale implantée en France depuis plus de 90 ans.

La responsabilità sociale del Gruppo GROSFILLEX

Attore industriale di primo piano nella progettazione e produzione di di attrezzature professionali e domestiche a base di materie plastiche, Grosfillex si impegna da diversi anni a ridurre l'impatto ambientale della propria attività attraverso 4 principali obiettivi.

LA PROTEZIONE DELL'AMBIENTE

- Materiali sostenibili e riciclabili per una maggiore durata di vita
- Economia circolare con l'utilizzo di materiali riciclati nei nuovi prodotti
- Riciclabilità dei materiali: il 100% degli scarti delle nostre linee di produzione viene selezionato, frantumato e rigenerato
- Gestione ottimizzata dell'energia. Nel 2022, ottenimento della certificazione ISO 50 001

LE CONDIZIONI DI LAVORO

- Una atmosfera di lavoro rispettosa degli impiegati; la sicurezza al primo posto

UNA POLITICA DI ACQUISTI RESPONSABILE

- Produzione francese responsabile in tutto il suo ecosistema economico e sociale

L'IMPRONTA LOCALE

- Un marchio familiare presente in Francia da oltre 90 anni.

Die soziale Verantwortung von GROSFILLEX

Grosfillex ist ein wichtiger Akteur in der Entwicklung und Herstellung von Produkten aus Kunststoffen für den Wohnbereich und engagiert sich seit mehreren Jahren in einer Fortschrittsinitiative, um die Auswirkungen seiner Tätigkeit auf den 4 Haupt-Aktionsfeldern zu reduzieren.

UMWELT

- Nachhaltige und wiederverwertbare Materialien mit langer Lebensdauer
- Kreislaufwirtschaft und Verwendung von recyceltem Material in neuen Produkten
- Recyclbarkeit von Materialien: 100% der Verschnitte aus unseren Produktionslinien werden sortiert, zerkleinert und wiederverwertet
- Energiemanagement . Im Jahr 2022 Erhalt der ISO 50 001-Zertifizierung

ARBEITSBEZIEHUNGEN & -BEDINGUNGEN

- Ein gutes Arbeitsklima; Sicherheit geht vor

FAIRNESS UND VERANTWORTUNGSVOLLE BESCHAFFUNG

- Französische Herstellung, die in ihrem gesamten Ökosystem verantwortlich ist

LOKALER FUSSABDRUCK

- Ein Familienunternehmen, das seit über 90 Jahren in Frankreich ansässig ist.



GROSFILLEX *matières*

beaucoup plus qu'un fabricant

Grâce à son expertise du composite, Grosfillex est devenu un créateur de matières innovantes, où l'esthétique s'allie à la performance pour rendre nos produits encore plus attractifs pour vos clients. De la résine polypropylène classique aux composites high tech, du textile PVC au hpl, les matières Grosfillex vous assurent praticité, durabilité, facilité d'entretien, résistance aux chocs, aux rayures, aux UV, aux intempéries, légèreté ou densité selon les besoins.

GROSFILLEX *materiali*

molto più che un fabbricante

Grazie alla sua esperienza nei materiali compositi, Grosfillex è diventata creatrice di materiali innovativi nei quali l'aspetto estetico si associa alle prestazioni per rendere i nostri prodotti ancora più accattivanti per i vostri clienti. Dalla classica resina di polipropilene alle miscele sintetiche high tech, dal tessuto in PVC all'HPL, i materiali Grosfillex vi garantiscono praticità, durevolezza, facilità di manutenzione, resistenza agli urti, ai graffi, ai raggi UV, alle intemperie, leggerezza o densità a seconda delle esigenze.

GROSFILLEX *werkstoffe*

viel mehr als ein hersteller

Dank seines Fachwissens über Verbundwerkstoffe ist Grosfillex ein Entwickler neuer Materialien geworden. Dabei vereinen sich Ästhetik mit Leistung, um unsere Produkte für Ihre Kunden noch attraktiver zu machen. Von klassischem Polypropylen bis hin zu High-Tech-Komposit, von PVC bis hin zu HPL, die Werkstoffe von Grosfillex sind praktisch, nachhaltig, pflegeleicht, schock-, kratz-, UV-, wetterbeständig, besonders leicht oder massiv, je nach Bedarf.



LA RÉSINE POLYPROPYLENE - UN GRAND CLASSIQUE

Polymère thermoplastique, le polypropylène de grade injection est recyclable, léger et hydrophobe.

- Au-delà de sa grande facilité d'entretien, il se distingue par des propriétés mécaniques exceptionnelles : haute résistance aux intempéries, aux températures extrêmes (gel), aux UV et aux chocs.
- Il est fréquemment chargé en fibres de verre à hauteur de 10 à 30%, pour renforcer sa résistance et sa durabilité.
- Avec des couleurs teintées dans la masse, il offre une large déclinaison de nuances et d'aspects.

LA RESINA DI POLIPROPILENE - UN GRANDE CLASSICO

Il polipropilene è un polimero termoplastico a iniezione riciclabile, leggero e idrofobo.

- Oltre alla sua facilità di manutenzione, si distingue per le sue eccezionali proprietà meccaniche: elevata resistenza alle intemperie, alle temperature estreme (gelo), ai raggi UV e agli urti.
- Viene spesso arricchito con una percentuale variabile dal 10% al 30% di fibre di vetro per rinforzarne la resistenza e aumentarne la durevolezza.
- Tinto in massa, offre un'ampia tavolozza di sfumature e di aspetti.

POLYPROPYLEN - DER KLASSIKER

Thermoplastisches Polymer: Eingespritztes Polypropylen ist recyclebar, leicht und wasserabweisend.

- Es ist nicht nur unglaublich pflegeleicht, sondern unterscheidet sich auch durch seine außergewöhnlichen mechanischen Eigenschaften: hohe Wetter-, Temperatur-, UV- und Stoßfestigkeit.
- Es wird regelmäßig mit 10 bis 30 % Glasfasern angereichert, die seine Widerstandsfähigkeit und Haltbarkeit verbessern.
- Mit durchgefärbtem Material ist es in vielen Nuancen und Dekoren erhältlich.

UN COMPOSITE HIGH TECH

Grosfillex innove avec un composite high tech nouvelle génération alliant une esthétique pleine de noblesse et des performances techniques exceptionnelles.

- Grâce à sa formulation spécifique associant des composants à forte valeur ajoutée (fibre de verre, particules d'aluminium...), ce composite se distingue immédiatement par son aspect qualitatif et son toucher caractéristique, qui en font le matériau de prédilection des gammes premium, comme Sunset.
- Véritable matière à création, elle permet une infinie créativité dans le design avec des formes audacieuses singulières.
- Anti-rouille, anti-moisissures, anti-UV, ses propriétés mécaniques et techniques font la différence dans tous les contextes d'utilisation intensive. Même en cas de très fortes sollicitations, sa durabilité reste optimale et toujours avec une extrême facilité d'entretien au quotidien... Des atouts décisifs pour le mobilier professionnel outdoor.

UN MATERIALE COMPOSITO HIGH TECH

Grosfillex innova con una lega sintetica nuova generazione che associa un aspetto nobile e prestazioni tecniche eccezionali.

- Grazie alla sua formula specifica che abbina componenti a forte valore aggiunto (fibra di vetro, particelle di alluminio, ecc.), questa nuova materia composita si distingue subito per il suo aspetto di qualità e la sua caratteristica consistenza al tatto, che la rendono il materiale prediletto per le gamme premium come Sunset.
- Questo materiale plasmabile permette di lasciare libero corso alla creatività nella creazione di design dalle forme audaci e singolari.
- Le sue proprietà meccaniche e tecniche (antiruggine, resistente alla muffa e ai raggi UV) fanno la differenza nel caso di un utilizzo intensivo. Sua durezza resta sempre ottimale, anche in caso di forti sollecitazioni, e il materiale è sempre facilissimo da pulire a livello quotidiano. Dei pregi primordiali per i mobili professionali per esterni.

EIN HIGH-TECH-VERBUNDWERKSTOFF

Grosfillex hat ein High-Tech-Komposit entwickelt. Diese neue Generation eines Materials vereint die Ästhetik mit besonderen technischen Eigenschaften.

- Dank seiner spezifischen Rezeptur, bei der Komponenten mit hohem Mehrwert (Glasfaser, Aluminiumpartikel, ...) vereint werden, unterscheidet sich dieses Komposit sofort durch seinen qualitativen Aspekt und seine charakteristische Haptik. Diese beiden Aspekte machen aus ihm den bevorzugten Verbundstoff der Premiumsortimente wie Sunset.
- Dieses Material unterstützt die Kreativität. Er lässt Platz für eine Kreativität ohne Grenzen mit einzigartigen, gewagten Formen.
- Zu seinen mechanischen und technischen Eigenschaften gehören Korrosionsbeständigkeit, Schimmelfestigkeit, UV-Beständigkeit und genau diese machen den Unterschied bei intensivster Nutzung. Selbst bei stärkster Beanspruchung bleibt die Stabilität optimal. Entscheidende Vorteile für professionelles Outdoor-Mobiliar.



LE TEXTILE PVC - SPÉCIAL OUTDOOR

Composé de fibres polyester gainées de PVC, ce matériau textile se décline en tissage 2 fils-2 fils ou 2 fils-1 fil et se caractérise par une grande solidité.

- Les toiles reçoivent un traitement Microban®, qui leur assure une protection anti-microbienne, anti-moisissures, antifongique, efficace même contre certaines souches de virus. Cette technologie est basée sur des additifs intégrés au processus de production, comme le zinc ou l'argent. Ces substances actives empêchent le développement incontrôlé de micro-organismes tout au long du cycle de vie du produit final.
- Résistants aux UV, ces textiles techniques sont certifiés Greenguard, grâce à leurs faibles émissions chimiques, respectueuses de la santé et de l'environnement.
- D'une grande élasticité, le maillage épouse les formes du corps et reprend naturellement son aspect d'origine, sans jamais s'affaisser.

IL TESSUTO IN PVC - SPECIALE PER ESTERNI

Composto da fibre di poliestere rivestite di PVC, questo materiale tessile è disponibile con una tessitura 2 fili-2 fili o 2 fili-1 filo ed è caratterizzato da una grande resistenza.

- I tessuti sono sottoposti a un trattamento Microban®, che garantisce loro una protezione antimicrobica, antimicotica e resistente alle muffe, efficace anche contro alcuni ceppi di virus. Questa tecnologia si basa su additivi integrati al processo di produzione, come lo zinco o l'argento. Tali sostanze attive impediscono lo sviluppo incontrollato di microorganismi durante la vita del prodotto finale.
- Resistenti ai raggi UV, questi tessuti tecnici sono certificati Greenguard grazie alle loro basse emissioni chimiche, rispettose della salute e dell'ambiente.
- La maglia, molto elastica, segue le forme del corpo e riprende autonomamente il suo aspetto originale senza cedere mai.

PVC-TEXTIL - SPEZIELL FÜR OUTDOOR-NUTZUNG

Dieser Textilverbundwerkstoff besteht aus mit PVC-beschichteten Polyesterfasern. Er präsentiert sich in 2x2-Fäden oder 2x1-Faden-Gewebearten und zeichnet sich durch eine hohe Stabilität aus.

- Die Gewebe erhalten eine Microban®-Behandlung, die ihnen antimikrobielle, schimmel-, pilzfeste Eigenschaften und sogar eine Beständigkeit gegen bestimmte Virusstämme verleiht. Diese Technologie beruht auf Zusatzstoffen, die dem Produktionsprozess zugefügt worden sind, wie Zink oder Silber. Diese aktiven Substanzen verhindern die unkontrollierte Entwicklung von Mikroorganismen während des gesamten Lebenszyklus des Endprodukts.
- Diese UV-beständigen, technischen Textilien besitzen dank ihrer schwachen chemischen gesundheitsschonenden und umweltfreundlichen Emissionen die Greenguard-Zertifizierung.
- Das Geflecht zeichnet sich durch eine große Elastizität aus und passt sich an die Formen des Körpers an. Es zieht sich nach Gebrauch wieder in den Ursprungszustand und hängt nicht durch.



LE HPL (high pressure laminate)

PLATEAUX DE TABLE HAUTES PERFORMANCES

Conformes à la norme européenne EN438, les panneaux composites sont fabriqués sous haute pression et à haute température pour agréger entre elles différentes couches de papier saturées de résine.

- Autoportant, très stable, ce matériau stratifié compact de forte densité cumule de multiples avantages : résistance à l'usure et aux rayures, aux chocs, aux UV, à l'humidité, non conducteur de chaleur et non poreux. Des qualités qui en font un matériau idéal pour les applications outdoor exigeantes et en particulier les plateaux de tables.
- Dernier atout, les panneaux HPL ne nécessitent aucune maintenance particulière et se nettoient simplement à l'eau avec un détergent doux. Les surfaces résistent parfaitement à la majorité des désinfectants et nettoyants ménagers courants, dès lors qu'ils ne sont ni abrasifs ni fortement alcalins.

L'HPL (High Pressure Laminate)

PIANI DEI TAVOLI AD ALTE PRESTAZIONI

Conformi allo standard europeo EN438, i pannelli compositi sono realizzati con un processo ad alta pressione e ad alta temperatura per aggregare i diversi strati di carta imbevuti di resina.

- Questo materiale stratificato, compatto, a forte densità, autoportante e molto solido dispone di diversi pregi: resistenza all'usura e ai graffi, agli urti, ai raggi UV, all'umidità, non è conduttore di calore e non è poroso. Tante qualità che lo rendono un materiale ideale per le applicazioni per outdoor più esigenti, e in particolare per i piani dei tavoli.
- I pannelli HPL non necessitano di una manutenzione particolare e si puliscono semplicemente con acqua e un detergente delicato. Le superfici resistono perfettamente alla maggior parte dei disinfettanti e detergenti domestici, a patto che non siano abrasivi né fortemente alcalini.

HPL (High Pressure Laminate)

HOCHFESTE TISCHPLATTEN

Entsprechend der europäischen Norm EN438 werden die Verbundplatten unter Hochdruck und bei hoher Temperatur hergestellt, um zwischen ihnen verschiedene in Harz getränkte Papierschichten aufzunehmen.

- Dieser kompakte, sehr stabile Verbundwerkstoff von sehr hoher Dichte ist selbsttragend und bietet zahlreiche Vorteile: er ist beständig gegen Verschleiß, Kratzer, Stöße, UV-Strahlen, Feuchtigkeit, leitet Wärme nicht weiter und ist nicht porös. Diese Qualitäten machen aus ihm den idealen Verbundwerkstoff für anspruchsvolle Outdoor-Anwendungen und insbesondere für Tischplatten.
- Das letzte As im Ärmel: HPL-Platten benötigen keine besondere Pflege und lassen sich ganz leicht mit Wasser und einem milden Reinigungsmittel reinigen. Die Oberflächen trotzen den meisten aktuellen Desinfektionsmitteln und Haushaltsreinigungsprodukten, solange sie nicht scheuernd oder stark alkalisch sind.



LE MÉTAL - STYLE ET RÉSISTANCE RÉUNIS

ACIER - Naturellement résistant aux températures extrêmes et aux chocs, il offre en plus toutes les garanties de parfaite tenue à la corrosion grâce à un traitement cataphorèse réalisé en usine : la pièce est immergée dans un bain de peinture hydrosoluble et un courant électrique fait migrer les particules de peinture en suspension uniformément sur toute sa surface.

ALUMINIUM - Métal de faible densité, léger et résistant aux déformations, il ne s'oxyde pas, même en utilisation longue durée en extérieur.

LE MÉTAL ET LA COULEUR - Après mise en forme, polissage et traitement cataphorèse, le métal subit un nettoyage minutieux avant la mise en teinte. L'application d'une peinture poudre polyester anti-UV est suivie d'un processus de cuisson, avec durcissement thermique à haute température, pour optimiser la tenue de la finition et répondre aux exigences extrêmes d'une utilisation outdoor. Les palettes de nuances et de textures sont infinies.

IL METALLO - STILE E RESISTENZA

ACCIAIO - Naturalmente resistente alle temperature estreme e agli urti, offre inoltre la garanzia di una perfetta resistenza alla corrosione grazie a un trattamento per cataforesi realizzato in fabbrica: il pezzo è immerso in un bagno di vernice idrosolubile e la corrente elettrica fa passare in modo uniforme le particelle di pittura in sospensione su tutta la superficie.

ALLUMINIO - Metallo a bassa densità, leggero e resistente alle deformazioni, non si ossida nemmeno con un lungo utilizzo all'aria aperta.

IL METALLO E IL COLORE - Dopo essere stato sagomato, levigato e sottoposto al trattamento per cataforesi, il metallo viene accuratamente pulito prima di essere verniciato. L'applicazione di una vernice in polvere di poliestere contro i raggi UV è seguita da un processo di cottura con indurimento termico ad alta temperatura per ottimizzare la resistenza della finitura e rispondere alle esigenze estreme di un impiego all'aria aperta. La varietà di colori e texture è infinita.

METALL - STIL UND BESTÄNDIGKEIT SIND HIER VEREINT

STAHL - Stahl ist natürlich temperatur- und stoßfest und dank einer im Werk durchgeführten kathodischen Tauchlackierung (Kataphorese) äußerst korrosionsbeständig: das Teil wird in ein wasserlösliches Farbenbad eingetaucht und Strom führt die schwebenden Farbpartikel gleichmäßig an die gesamte Oberfläche.

ALUMINIUM - Aluminium ist ein leichtes, formfestes Metall von geringer Dichte, es rostet auch nicht nach langer Nutzungsdauer im Freien.

METALL UND FARBE - Nach der Formung, Verfeinerung und Behandlung durch elektrolytische Abscheidung wird das Metall vor dem Anstrich einer gründlichen Reinigung unterzogen. Auf die Anwendung mit einer Farbe aus Polyesterpulver mit UV-Schutz folgt ein Backverfahren mit thermischer Härtung bei hoher Temperatur, um den Halt der Ausführung zu optimieren und den extremen Anforderungen bei einer Outdoor-Nutzung gerecht zu werden. Es gibt unzählige Farbnuancen und Texturen.



L'IMPRESSION NUMÉRIQUE - DES DÉCORS INTÉPRELS

Employée pour les revêtements muraux et les plateaux de tables Color Top, l'impression numérique permet de reproduire texte ou images depuis un simple fichier numérique sur tous types de supports.

- La technologie à jet d'encre utilise des encres liquides UV LED disponibles en 6 couleurs.
- Les impressions sont ensuite protégées par un vernis qui leur apporte une valeur ajoutée esthétique de finition et d'aspect (texture, relief...) mais aussi technique, avec une résistance accrue à la rayure, à l'abrasion et au frottement.
- Pour l'entretien, tous les nettoyants ménagers courants sont utilisables, lorsqu'ils ne sont pas abrasifs.
- Sans impact sur l'environnement et la santé, cette technologie d'impression répond à toutes les exigences liées aux émissions de COV avec un classement A+, le plus haut niveau, pour la qualité de l'air intérieur.

LA STAMPA DIGITALE - DECORAZIONI SEMPRE ALLA MODA

Impiegata per i rivestimenti murali e i piani dei tavoli Color Top, la stampa digitale permette di riprodurre testi o immagini su ogni tipo di supporto a partire da un semplice file digitale.

- La tecnologia a getto d'inchiostro usa inchiostri liquidi UV LED disponibili in 6 colori.
- Le stampe sono poi protette con una vernice che dona loro un valore aggiunto a livello estetico, nelle finiture e nell'aspetto (texture, rilievo, ecc.), ma anche tecnico grazie a una maggiore resistenza ai graffi, all'abrasione e alla frizione.
- Per la pulizia si possono impiegare tutti i detergenti domestici, a patto che non siano abrasivi.
- Questa tecnologia di stampa senza impatto sull'ambiente e sulla salute risponde a tutte le esigenze legate alle emissioni di COV ed è di categoria A+, il livello più elevato, per la qualità dell'aria interna.

DIGITALER DRUCK - ZEITLOSE DEKORATIONEN

Der Digitaldruck wird für Wandverkleidungen und Color-Top-Tischplatten verwendet. Auf diese Weise können Texte oder Bilder von einer digitalen Datei aus auf alle Trägertypen kopiert werden.

- Bei der Tintenstrahltechnologie werden flüssige UV-LED-Tinten verwendet, die in 6 Farben verfügbar sind.
- Die Drucke werden danach mit einem Lack geschützt, der die Ästhetik der Ausführung und des Aspekts (Textur, Relief, ...) verschönert, aber auch technisch gesehen eine bessere Beständigkeit gegen Kratzer, Abrasion und Scheuern bietet.
- Was die Pflege angeht, kann man alle aktuellen Haushaltsreiniger verwenden, solange sie nicht scheuernd sind.
- Diese umweltfreundliche und gesundheitsschonende Drucktechnologie entspricht allen Anforderungen, die mit den OCV-Emissionen verbunden sind. Sie erhält eine A+-Einstufung, Die maximal erreichbare Einstufung in Bezug auf Emissionen in Innenräumen



ORIGINAL
SUNSET
CANNES
WESTPORT
INDEX

SOMMAIRE - INDICE - ÜBERSICHT

COLLECTION GROSFILLEX ORIGINAL

ORIGINAL

COLLECTION SUNSET CONFORT & SUNSET

SUNSET

COLLECTION CANNES

CANNES

COLLECTION WESTPORT

WESTPORT

INDEX
INDICE
INDEX

INDEX



Grosfillex[®] original



#INSTANPOREL*

* Vivez des instants intemporels

Chez Grosfillex Original,
chaque meuble est le fruit d'une histoire.
Une histoire qui se nourrit du passé,
se conjugue au présent
et demeurera dans le futur.

Le passé nous inspire car il a accompagné vos plus beaux
moments de convivialité mais aussi notre réussite.

Le présent nous inspirera pour construire
au mieux les instants de vie des générations à venir.

De cette vision, nous vous proposons aujourd'hui
des produits iconiques provenant du passé qui seront
indémontables demain.

**Un design intemporel pour vous offrir des instants
de convivialité qui durent pour toujours !**

#INSTAFINITY*

* Live timeless moments

*Da Grosfillex Original,
ogni mobile è il frutto di una storia.
Una storia che si nutre del passato,
si coniuga al presente
e rimarrà nel futuro.*

*Il passato ci ispira perché ha accompagnato i vostri più bei
momenti di convivialità ma anche il nostro successo.
Il presente ci ispirerà per costruire al meglio i momenti
di vita delle generazioni a venire.*

*Oggi, di questa visione, vi proponiamo dei prodotti
iconici provenienti dal passato che un domani
non passeranno mai di moda.*

**Un design eterno per offrirvi dei momenti
di convivialità che durano per sempre!**

*Godetevi istanti atemporalì

Jedes Möbelstück aus der Linie
Grosfillex Original hat seine eigene Geschichte.
Diese Geschichten werden aus der Vergangenheit genährt,
setzen sich im Heute fort und
haben auch in der Zukunft Bestand.

Wir werden von Vergangenen inspiriert, von erlebten
Momenten der Geselligkeit aber auch des Erfolgs.
In der Gegenwart schaffen wir die Grundsteine
schöner Momente für die kommenden Generationen.

Aus dieser Vision heraus, bieten wir Ihnen
heute Kultprodukte der Vergangenheit,
die auch morgen noch modern sind.

**Zeitloses Design, dass Sie in geselligen,
bleibenden Momenten begleitet!**

*Erleben Sie unvergängliche Momente



Liberté - Égalité - Fraternité

RAMATUELLE 73'



- ORIGINAL
- SUNSET
- CANNES
- WESTPORT
- INDEX

RAMATUELLE 73'

Chaise - *Sedia* - Stuhl

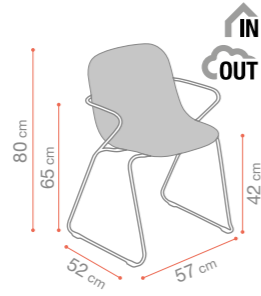

Chaise haute -
Sgabello alto - Hochstuhl

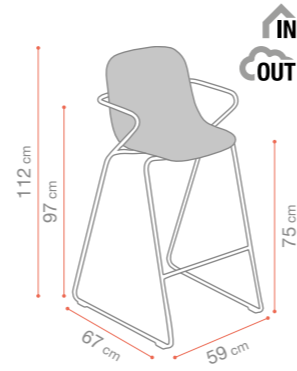

Résine Polypropylène - *Resina di polipropilene* - Polypropylenharz



Acier traité cataphorèse
Acciaio con verniciatura per cataforesi
Stahl Durch Kataphorese



RAMATUELLE 73'

Coussin - *Cuscino* - Kussen 

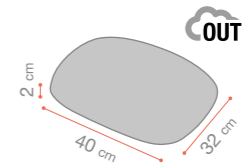

Acrylique - *Acrilico* - Acryl



* Dans la limite des stocks disponibles * *Serie limitata* * Solange der Vorrat reicht

ORIGINAL

SUNSET

CANNES

WESTPORT

INDEX

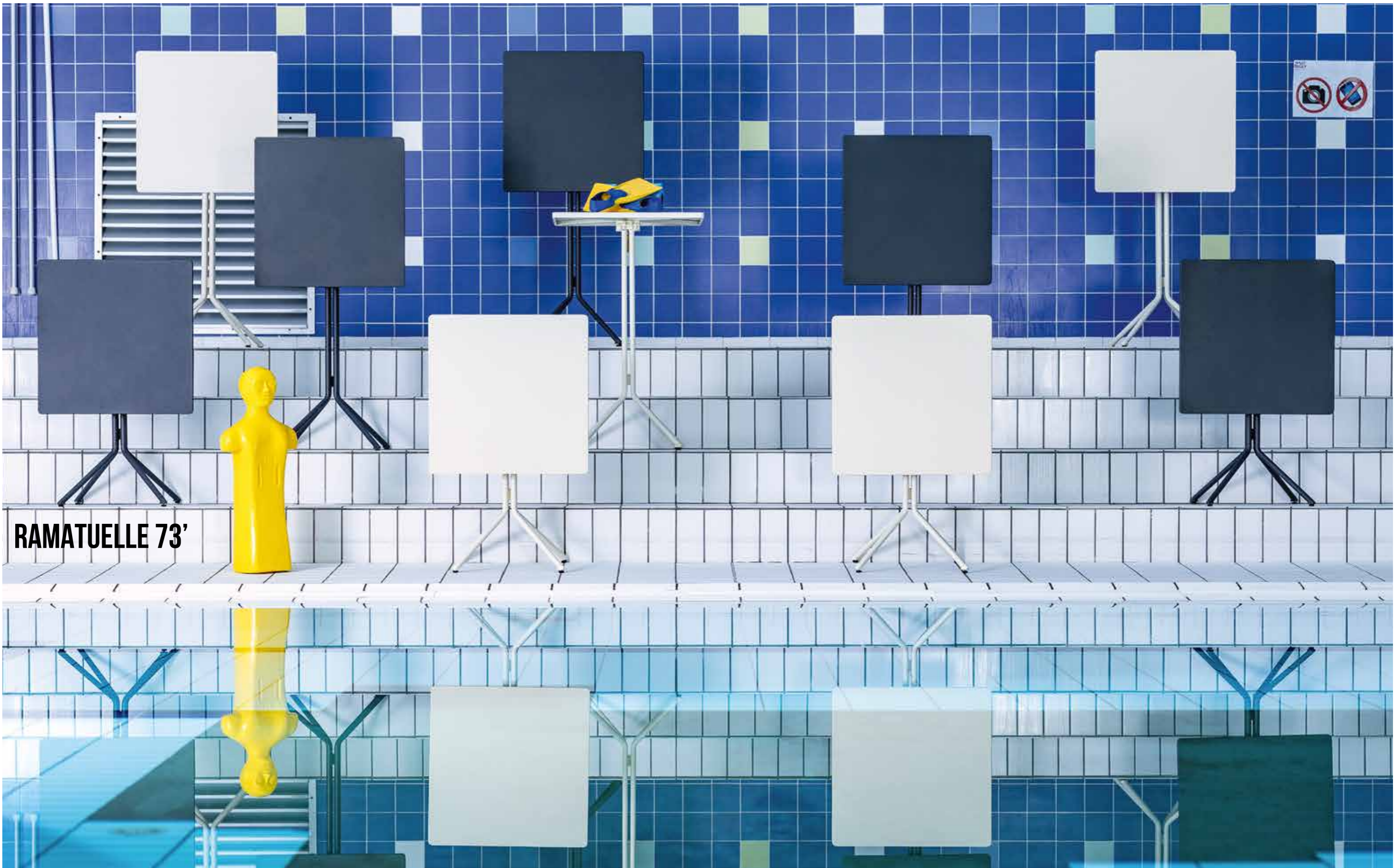

RAMATUELLE 73'

RAMATUELLE 73'

DUO Table - *Tavolo ribaltabile* - Tisch

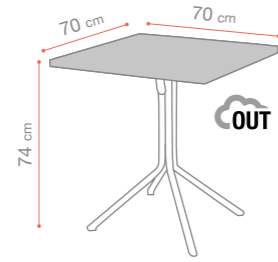

DUO Table haute -
Tavolo alto - Hochtisch

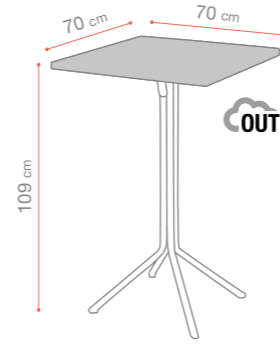

Acier traité cathodique
Acciaio con verniciatura per catodi
Stahl Durch Kataphorese



RAMATUELLE 73'

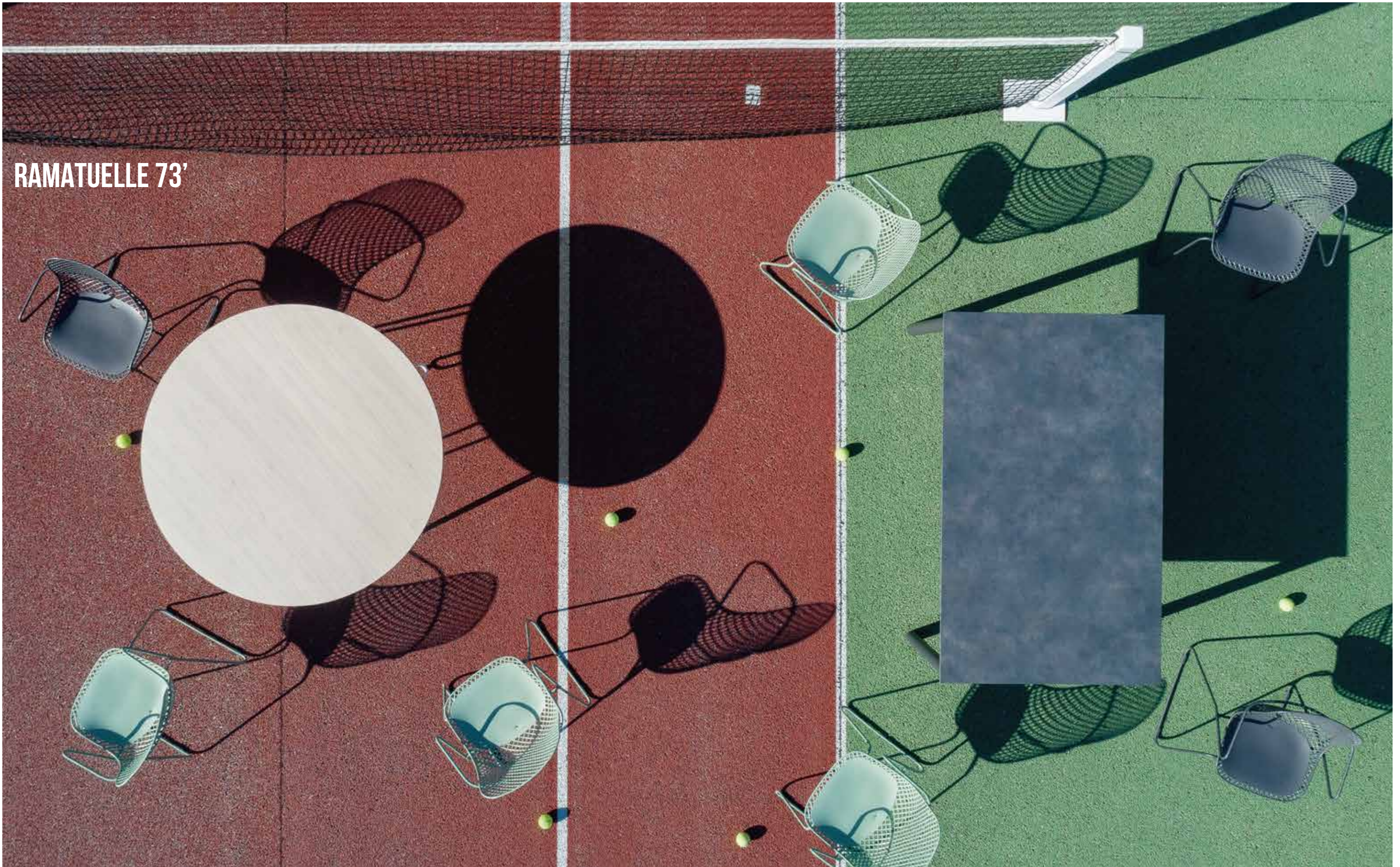

Martignat (01) - Terrain de tennis - France

RAMATUELLE 73'

Table ronde - *Tavola rotonda* - Runden Tisch

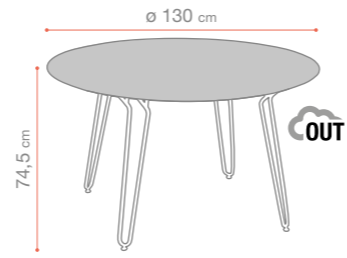

HPL Naturale 8 mm



HPL Nero 8 mm



Acier traité cataphorèse
Acciaio con verniciatura per cataforesi
Stahl Durch Kataphorese



ORIGINAL
SUNSET
CANNES
WESTPORT
INDEX

NEW

RAMATUELLE 73'

Table extensible - *Tavolo allungabile* - Ausziehtisch

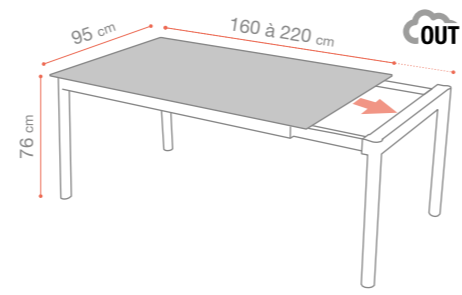

160 cm



HPL 8 mm Gris Cryptic



Aluminium - *Alluminio* - Aluminium



220 cm

ORIGINAL
SUNSET
CANNES
WESTPORT
INDEX

RAMATUELLE 73'

Restaurant Le Tokyo Lausanne - Suisse

RAMATUELLE 73'

Autour du monde - *Intorno al mondo* - Rund um die Welt



© STÉPHANE COUCHET

ORIGINAL
SUNSET
CANNES
WESTPORT
INDEX

RAMATUELLE 73'

Playa Beach hotel



Guinguette Rosa Bonheur *Quai de Seine - Paris - France*

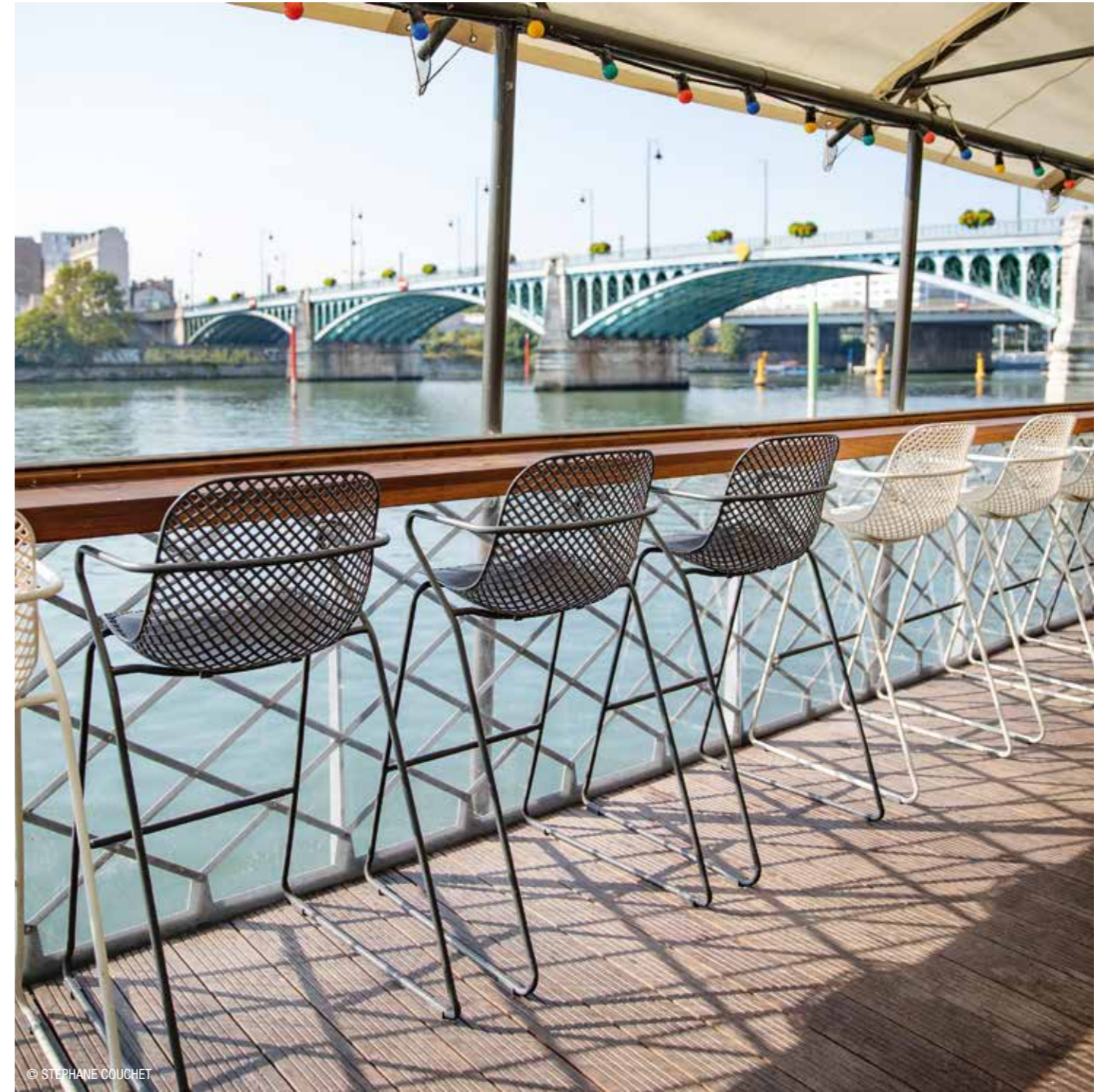

RAMATUELLE 73'

Molitor Paris (75) - France



© STÉPHANE COUCHET

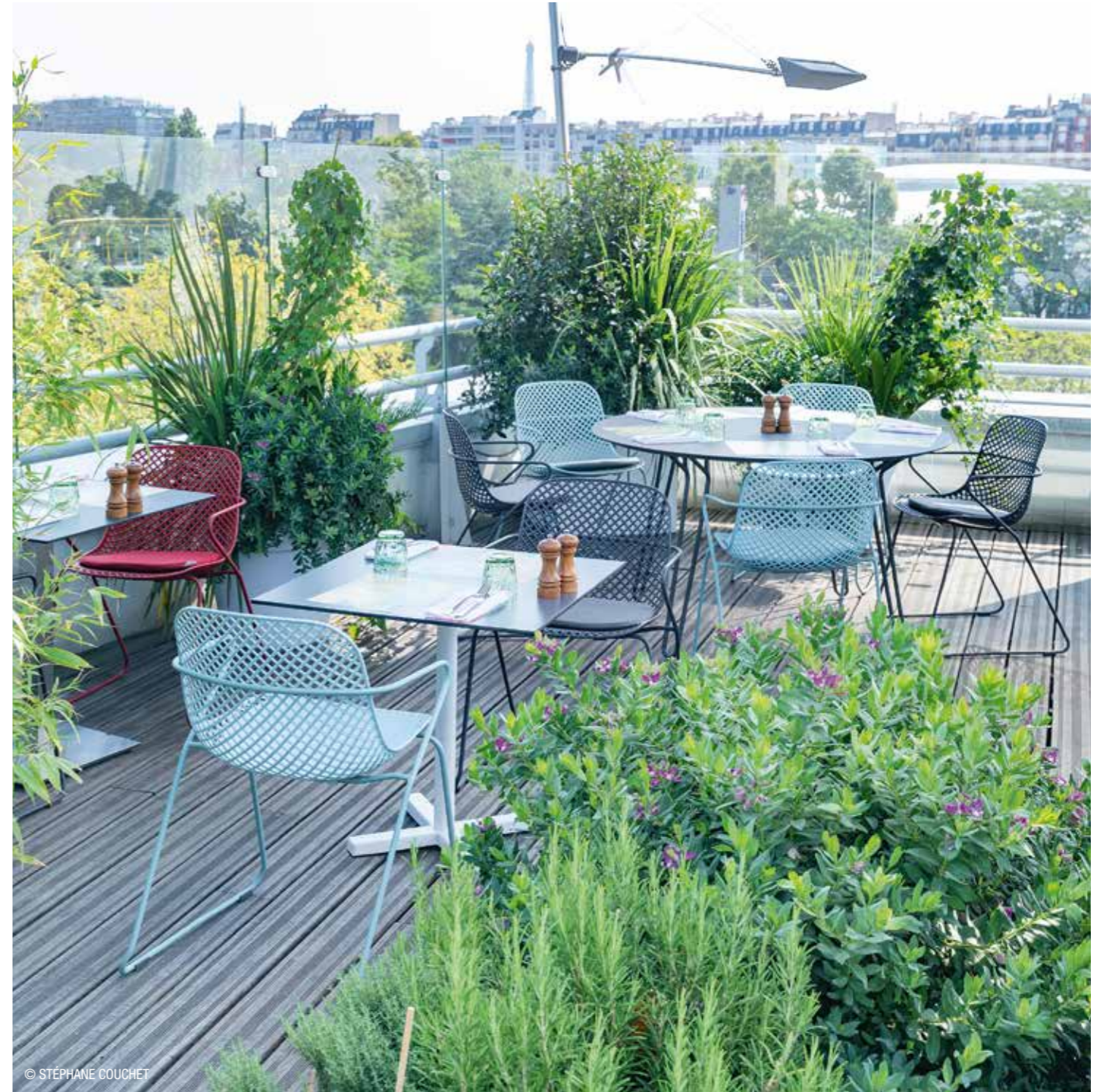

© STÉPHANE COUCHET

ORIGINAL

SUNSET

CANNES

WESTPORT

INDEX

45

NEW

RAMATUELLE 73'



ORIGINAL

SUNSET

CANNES

WESTPORT

INDEX

YÉYÉ 72'



Oyonnax (01) - Centre ville - France

ORIGINAL

SUNSET

CANNES

WESTPORT

INDEX

YÉYÉ 72'

Fauteuil - *Sedia Relax* - Sessel

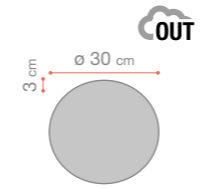
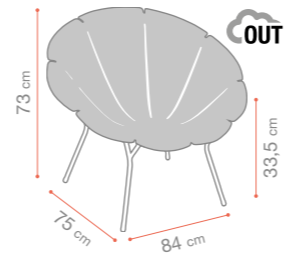

Coussin - *Cuscino* - Kissen 

Acrylique - *Acrilico* - Acryl



Résine Polypropylène
Resina di polipropilene - Polypropylenharz



Acier traité cathodique
*Acciaio con verniciatura per cataforesi
Stahl Durch Kataphorese*



YÉYÉ 72'

Autour du monde - *Intorno al mondo* - Rund um die Welt



© STÉPHANE COUCHET

YÉYÉ 72'

Hôtel Beau Rivage *Lausanne - Suisse*



© STÉPHANE COUCHET



© STÉPHANE COUCHET

ORIGINAL

SUNSET

CANNES

WESTPORT

INDEX

YÉYÉ 72'

La clusaz - France



© STÉPHANE COUCHET

Casa Coco Lloret de Mar - Espagne



ORIGINAL
SUNSET
CANNES
WESTPORT
INDEX

COLLECTION
SUNSET
SUNSET CONFORT
GREEN EDITION **NEW**

SUNSET

L'accord parfait du design et de la technologie - *L'incontro perfetto tra design e tecnologia*
Die perfekte Übereinstimmung von Design und Technologie

Grace à la technologie injection gaz, la collection SUNSET reprend les codes emblématiques du métal pour un résultat étonnant. Réalisée avec le nouveau matériau composite high tech de Grosfillex, SUNSET se distingue par son aspect qualitatif et son toucher caractéristique. Des atouts décisifs pour un mobilier outdoor destiné à une utilisation intensive.

Grazie alla tecnologia d'iniezione a gas, la collezione SUNSET riprende le caratteristiche emblematiche del metallo per un risultato sorprendente. Realizzata con la nuova lega composita di Grosfillex, SUNSET si distingue per l'aspetto qualitativo e il tocco caratteristico. Dei punti di forza decisivi per arredi outdoor destinati a un utilizzo intensivo.

Dank der Gasinjektionstechnologie werden in der Kollektion SUNSET die emblematischen Codes des Metalls für ein überraschendes Ergebnis übernommen. Die Kollektion SUNSET besteht aus Tech-Komposit Material, dem brandneuen Verbundwerkstoff von Grosfillex, und unterscheidet sich durch ein hochwertiges Erscheinungsbild und die charakteristische Haptik. Entscheidende Vorteile für Outdoor-Möbel bei höchster Beanspruchung.

Composite high tech - *Lega esclusiva High-tech* - High-Tech-Verbundwerkstoff

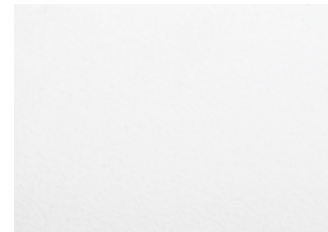

Blanc Glacier
Bianco ghiacciaio
Schneeweiss



Gris platinum
Grigio platino
Platingrau



Noir volcanique
Nero vulcanico
Vulkanschwarz



Bronze fusion
Bronzo fuso
Bronze Fusion

Textile PVC special outdoor - *Tessuto sintetico speciale Outdoor* - PVC-BESPANNUNG speziell auch für outdoor gebrauch



TRAITEMENT MICROBAN : protection anti-microbienne, anti-moisissures, antifongique.
TRATTAMENTO MICROBAN : protezione antimicrobica, antimuffa, antimicotica.
BEHANDLUNG MICROBAN : antimikrobieller Schutz, Antischimmel, Antimykotikum.

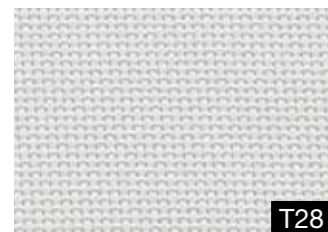

Blanc - Bianco - Weiß

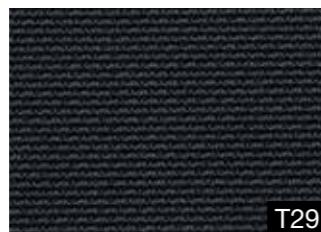

Noir - Nero - Schwarz

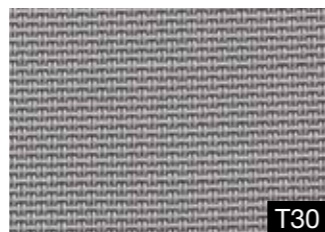

Gris - Grigio - Grau

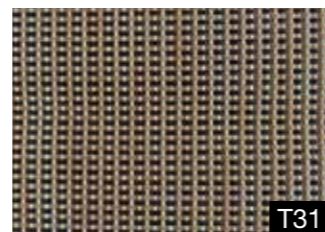

Cognac

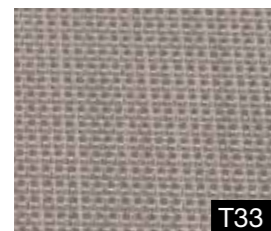

Beige chiné
Beige mélange
Meliertes Beige

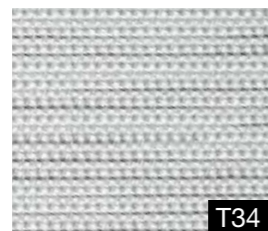

Gris chiné
Grigio mélange
Meliertes Grau

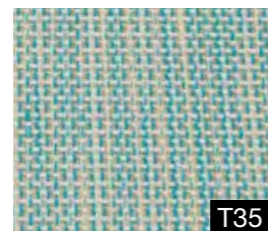

Turquoise chiné
Turchese mélange
Meliertes Türkis



Brun chiné
Marrone mélange
Meliertes Braun

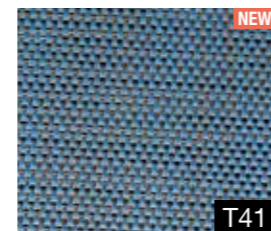

Bleu Madras
Blu Madras
Blau Madras



Coussin alvéolaire intégré respirant.
Ne retient pas l'eau, sèche rapidement.
Cuscino alveolare integrato traspirante.
Non trattiene l'acqua, si asciuga rapidamente.
Integriertes, wabenförmiges, atmungsaktives Kissen Saugt kein Wasser auf, trocknet schnell.

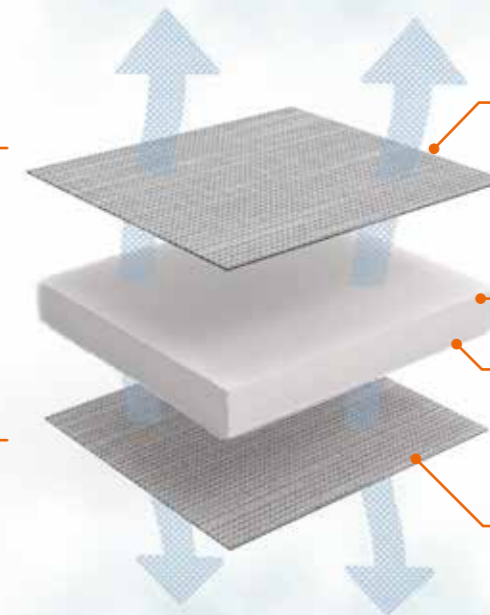

Textile PVC traité anti-UV
Telo in PVC con trattamento anti-UV
PVC-Textylenstoff mit Anti-UV-Behandlung

Mousse à cellules ouvertes 30 Kg/m³
Schiuma a cellule aperte 30 Kg/m³
Offenporiger Schaumstoff 30 kg/m³
Perméabilité à 95%
Permeabilità al 95%
Durchlässigkeit von 95 %

Textile PVC traité anti-UV
Telo in PVC con trattamento anti-UV
PVC-Textylenstoff mit Anti-UV-Behandlung

SUNSET & SUNSET CONFORT

Changez de toile en 5 min - *Sostituzione del telo in 5 minuti* - Wechseln Sie den Bezug in 5 Minuten



La collection Sunset a été pensée pour vous faciliter la vie, les cadres toiles sont démontables et se changent en toute simplicité.

La collezione Sunset è stata pensata per semplificarvi la vita, i teli sono smontabili e sostituibili in tutta semplicità.

Die Kollektion Sunset ist so konzipiert, dass Sie Ihnen das Leben leichter macht. Die Rahmen können abgenommen werden und lassen sich ganz einfach austauschen.

	TOILE DE RECHANGE DISPONIBLE	TELI DI SOSTITUZIONE DISPONIBILI	ERSATZBEZUG ERHÄLTlich
	+ DURABLE	+ DUREVOLE	+ NACHHALTIG
	+ RESPONSABLE	+ RESPONSABILE	+ VERANTWORTUNGsvOLL

ORONET 17

Pour entretenir facilement vos toiles Sunset et Sunset Confort.
Per una facile manutenzione dei teli Sunset e Sunset Confort.
Für eine einfache Pflege Ihrer Bezüge aus der Reihe Sunset und Sunset Confort.



ORIGINAL
SUNSET
CANNES
WESTPORT
INDEX

SUNSET GREEN EDITION

Une collection engagée - Una collezione che si impegna - Eine engagierte Kollektion

Grosfillex s'est engagé depuis plusieurs années à réduire les impacts environnementaux de son activité. La Collection SUNSET GREEN EDITION en est le fruit.

Grâce à l'intégration de matières recyclées et l'utilisation d'une toile plus écologique, le mobilier Green Edition devient plus respectueux de l'environnement.

Grosfillex si è impegnata da diversi anni a ridurre gli impatti ambientali della sua attività. La Collezione SUNSET GREEN EDITION ne è il frutto.

Grazie all'integrazione di materiali riciclati e all'utilizzo di una tela più ecologica, i mobili Green Edition diventano più rispettosi dell'ambiente.

Grosfillex setzt sich seit mehreren Jahren für Fortschritt ein, der darauf ausgerichtet ist, die Umweltauswirkungen seiner Aktivitäten zu reduzieren. Die SUNSET GREEN EDITION ist das Ergebnis daraus.

Durch die Verwendung von recycelten Materialien sowie umweltfreundlicheren Stoffen tragen die Möbel der GREEN EDITION zum Schutz der Umwelt bei.

Composite Green Edition - Edizione Green Edition - Komposit Green Edition

La double maîtrise de la résine et des procédés de transformation ont permis le développement du nouveau composite Green Edition, validé par des essais et tests laboratoires. Composé à 50% de matière recyclée issue de déchets industriels revalorisés, le Mobilier Green SUNSET garantit un niveau de qualité et de performance identiques aux produits réalisés en matière vierge. 100% recyclable, ce composite peut être recyclé plusieurs fois avant d'atteindre sa fin de vie.

La doppia padronanza della resina e dei processi di trasformazione hanno permesso lo sviluppo del nuovo composito Green Edition, convalidato da prove e test di laboratorio. Composto al 50% da materiale riciclato proveniente da rifiuti industriali rivalorizzati, il Mobilio Green SUNSET garantisce un livello di qualità e di prestazione identico ai prodotti realizzati in materiale vergine. 100% riciclabile, questo composito può essere riciclato più volte prima di raggiungere la fine del suo ciclo vitale.

Das Know-How im Bereich des Materials Kunststoff und der Fertigungsprozesse hat zur Entwicklung der neuen Verbundserie Green Edition geführt, bestätigt durch Laborversuche und Tests. Green SUNSET Möbel bestehen zu 50% aus recyceltem Material, das aus wiederverwerteten Industrieabfällen stammt. SUNSET Green Mobiliar garantiert das gleiche Qualitäts- und Leistungsniveau wie Produkte, die aus neuem Material hergestellt werden. Das Material ist zu 100 % recycelbar und kann mehrfach recycelt werden, bevor es sein Lebensende erreicht.



Vert Lichen

Ecolibrium™ Dow



Coton

La toile Sunset Green Edition est un nouveau textile outdoor qui utilise le plastifiant écologique ECOLOBRIUM™ de DOW, issu du végétal. ECOLOBRIUM™ est une alternative renouvelable aux plastifiants plastiques. Il permet de réduire jusqu'à 40% les émissions de gaz à effet de serre par rapport aux PVC existants. Sunset Green Edition biobased conserve toutes les propriétés d'un tissu vinyle classique : durabilité, facilité de nettoyage et longévité.

La tela Sunset Green Edition è un nuovo tessuto outdoor che utilizza il plastificante ecologico ECOLOBRIUM™ di DOW, proveniente da vegetali. ECOLOBRIUM™ è un'alternativa rinnovabile ai plastificanti plastici. Consente di ridurre fino al 40% le emissioni di gas serra rispetto ai PVC esistenti. Sunset Green Edition biobased conserva tutte le proprietà di un tessuto vinile classico: durata, facilità di pulizia e durata.

Der Stoff "Sunset Green Edition" ist ein neues Outdoor-Textil, das den umweltfreundlichen, aus Pflanzen gewonnenen Weichmacher ECOLOBRIUM™ von DOW verwendet. ECOLOBRIUM™ ist eine erneuerbare Alternative zu Kunststoffweichmachern. Es reduziert die Treibhausgasemissionen im Vergleich zu existierendem PVC um bis zu 40%. Sunset Green Edition biobased behält alle Eigenschaften eines klassischen Vinylstoffs: Haltbarkeit, leichte Reinigung und Langlebigkeit.

Changez de toile en 5 min
Sostituzione del telo in 5 minuti
Wechseln Sie den Bezug in 5 Minuten



TOILE DE RECHANGE DISPONIBLE	TELI DI SOSTITUZIONE DISPONIBILI	ERSATZBEZUG ERHÄLTlich
+ DURABLE	+ DUREVOLE	+ NACHHALTIG
+ RESPONSABLE	+ RESPONSABILE	+ VERANTWORTUNGsvOLL



TRAITEMENT MICROBAN :

Protection anti-microbienne, anti-moisissures, antifongique.
Protezione antimicrobica, antimuffa e antimicotica.
Antimikrobieller Schutz, Anti-Schimmel, Antimykotika.



NEW

SUNSET GREEN EDITION

Bain de soleil - *Lettino imbottito* - Sonnenliegen

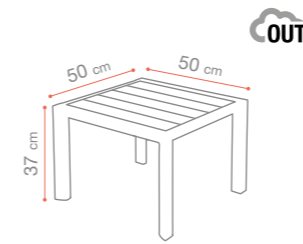
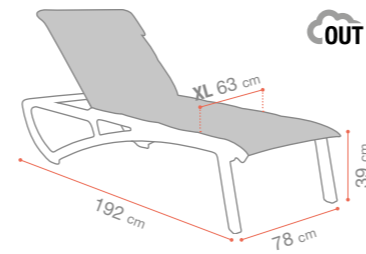

Table basse carrée - *Tavolino quadrato* - Quadratischer niedrig Tabelle

NEW

ORIGINAL

SUNSET

CANNES

WESTPORT

INDEX



Aluminium - *Aluminio* - Aluminium

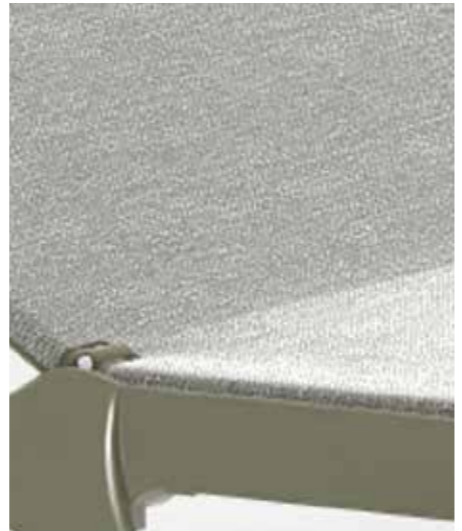

Composite Green Edition





SUNSET CONFORT

SUNSET CONFORT

Fauteuil - Poltrona imbottita - Gartensessel

DURABLE
DUREVOLE
NACHHALTIG

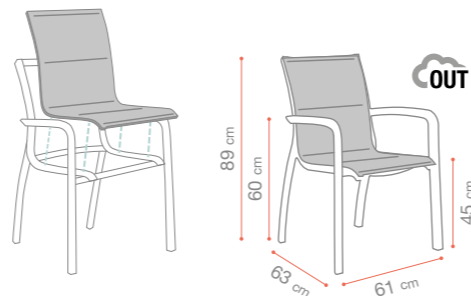

Composite high tech - *Composito high tech* - High-Tech-Komposit



Textile PVC, coussin confort
Tessuto in PVC, Telo imbottito
PVC-Textil, Komfortkissen



SUNSET

Table ronde - *Tavola rotonda* - Runden Tisch

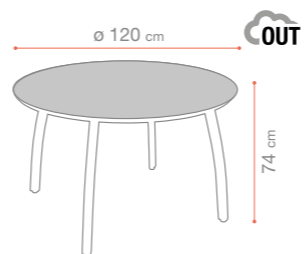

HPL Brun Cryptic 6 mm



Aluminium - *Alluminio* - Aluminium



SUNSET

Table carrée - *Tavolo quadrato* - Quadratischer Tisch

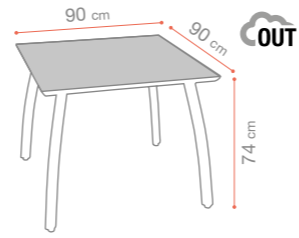

Aluminium - *Alluminio* - Aluminium



HPL Gris Cryptic 6 mm



SUNSET CONFORT

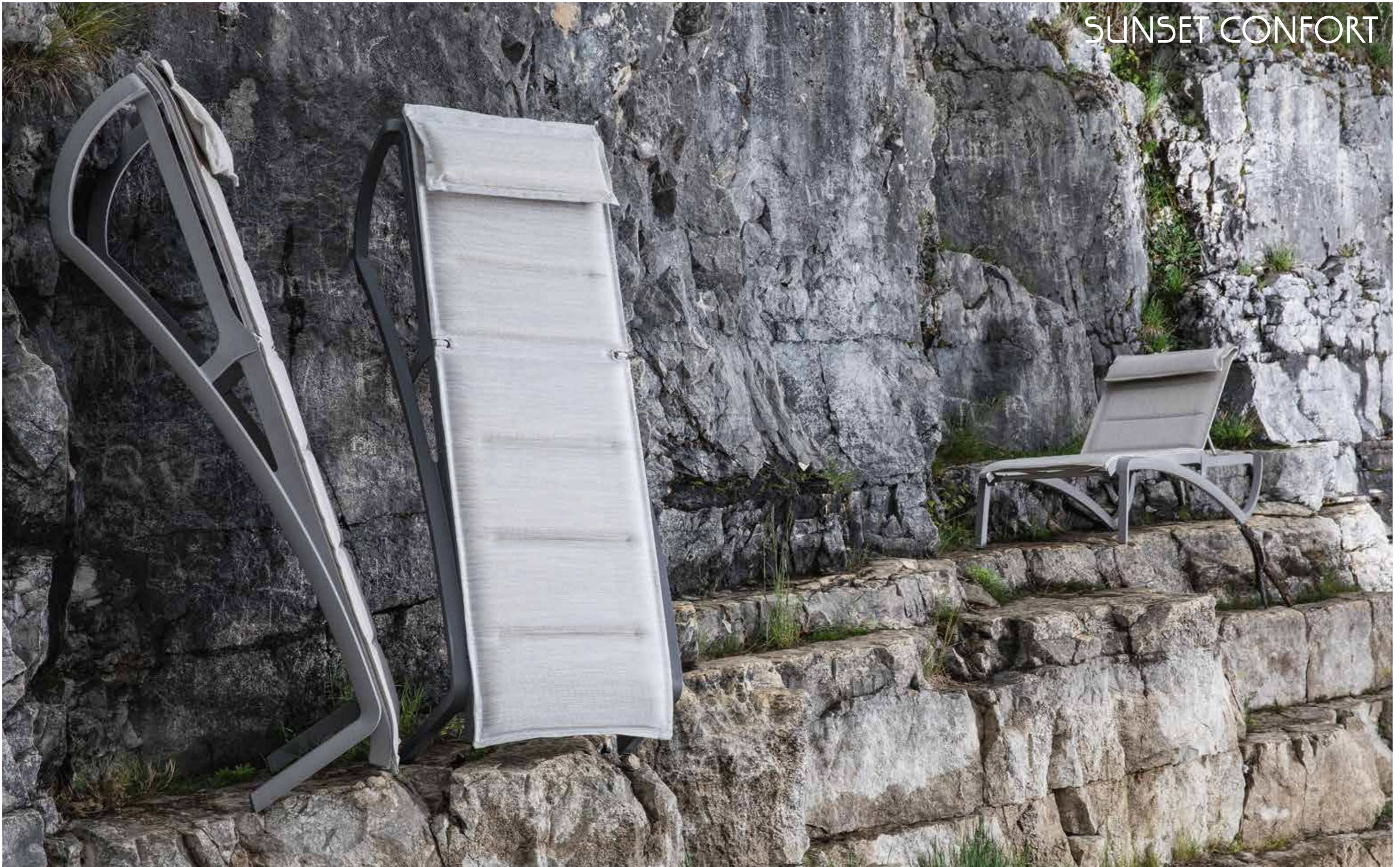

ORIGINAL

SUNSET

CANNES

WESTPORT

INDEX

SUNSET CONFORT

Bain de soleil - Lettino imbottito - Sonnenliegen

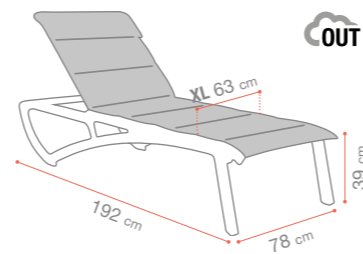
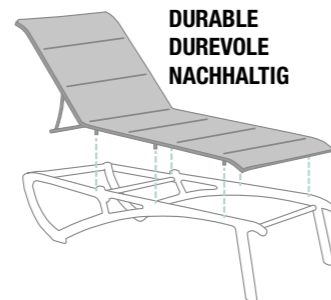

Textile PVC, coussin confort
Tessuto in PVC, Telo imbottito con poggiatesta
PVC-Textil, Komfortkissen



Composite high tech - *Composito high tech*
High-Tech-Komposit



SUNSET

Tablette - Tavolozza centrale - Tablett

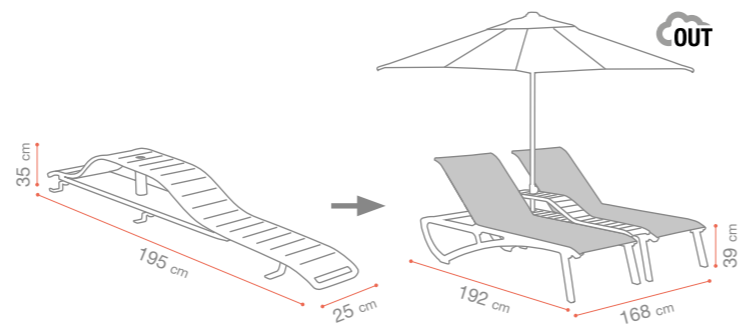

Aluminium - Alluminio - Aluminium



SUNSET CONFORT



ORIGINAL

SUNSET

CANNES

WESTPORT

INDEX

SUNSET CONFORT

Conversationnel fauteuil - Poltrona Lounge -
Lounge-Sessel

DURABLE
DUREVOLE
NACHHALTIG

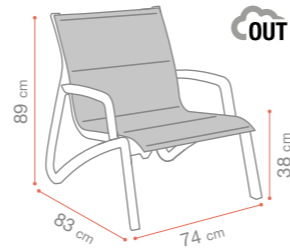
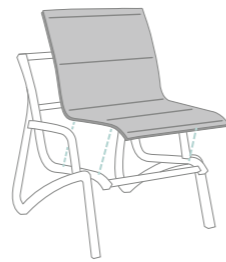

Composite high tech
Composito high tech
High-Tech-Komposit



Textile PVC, coussin confort
Tessuto in PVC, Telo imbottito
PVC-Textil, Komfortkissen



ORIGINAL
SUNSET
CANNES
WESTPORT
INDEX

SUNSET CONFORT

Conversationnel canapé - *Divano Lounge* -
Lounge-Sofa

DURABLE - DUREVOLE - NACHHALTIG

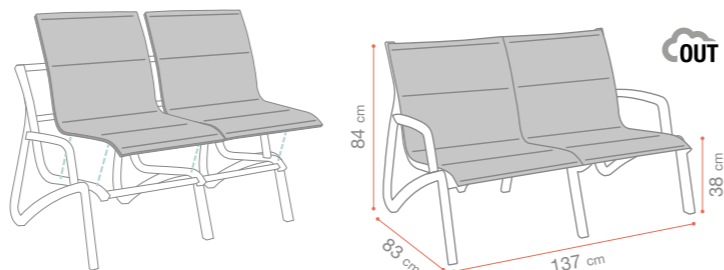

Textile PVC, coussin confort
Tessuto in PVC, Telo imbottito
PVC-Textil, Komfortkissen



Composite high tech - *Composito high tech*
High-Tech-Komposit



SUNSET

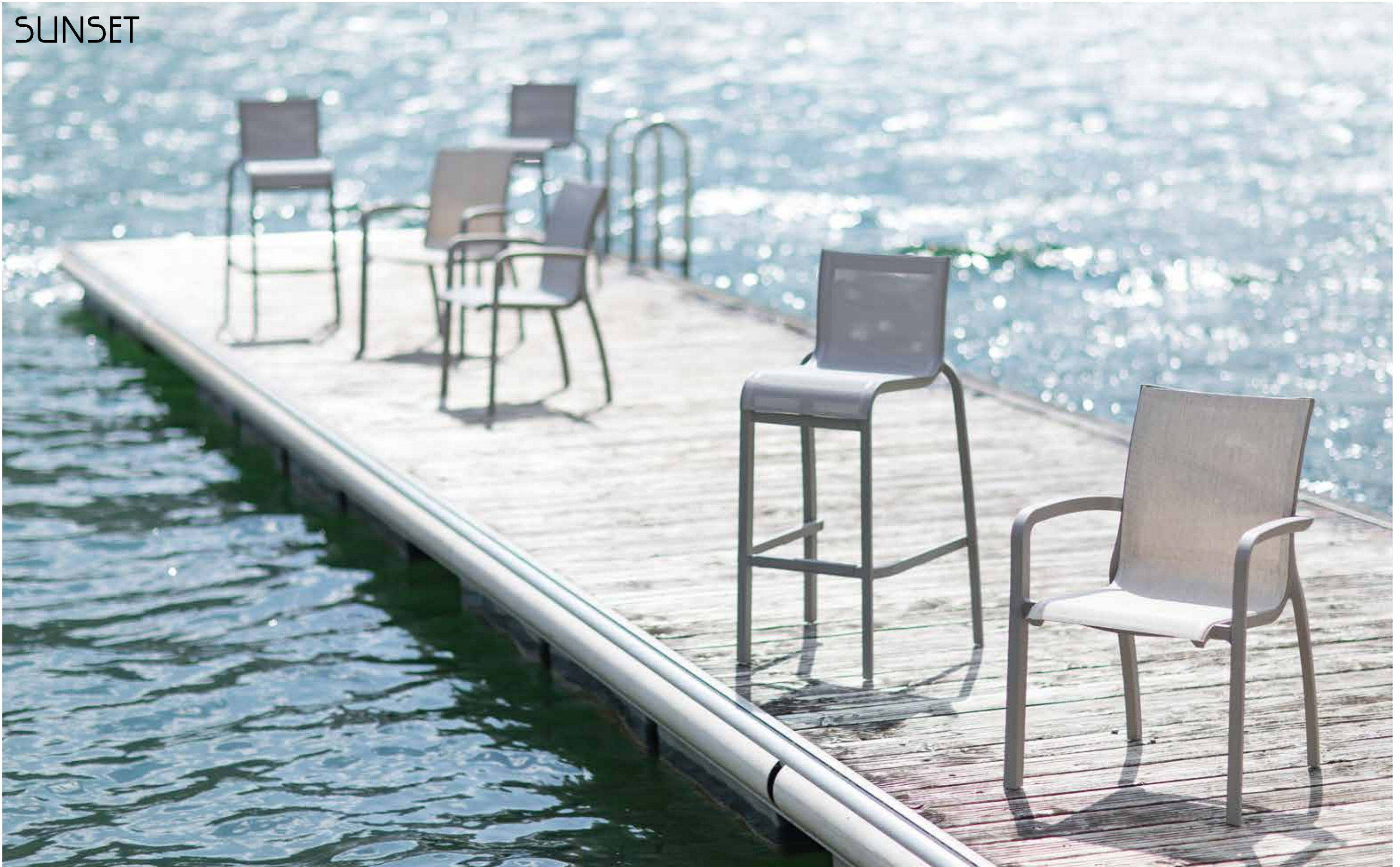

ORIGINAL

SUNSET

CANNES

WESTPORT

INDEX

SUNSET

Fauteuil - Poltrona - Stuhl

DURABLE
DUREVOLE
NACHHALTIG

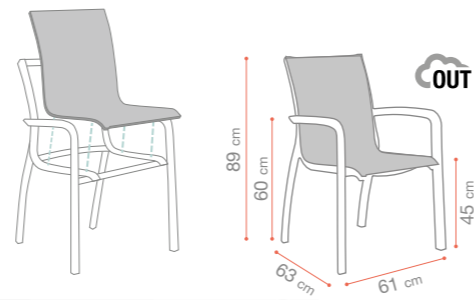

Composite high tech - *Composito high tech*
High-Tech-Komposit



Textile PVC - *Tessuto in PVC* - PVC-Textil



ORIGINAL
SUNSET
CANNES
WESTPORT
INDEX

SUNSET

Chaise haute - *Sgabello alto* - Hoher Barstuhl

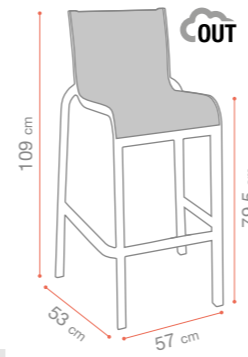

Textile PVC - *Tessuto in PVC* - PVC-Textil



Aluminium - *Alluminio* - Aluminium



SUNSET

Table ronde - *Tavola rotonda* - Runden Tisch

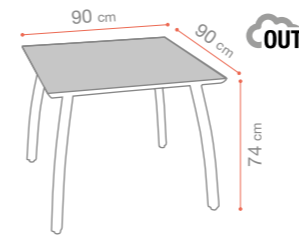
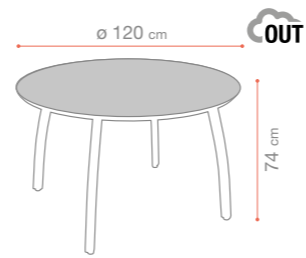

SUNSET

Table carrée - *Tavolo quadrato* - Quadratischer Tisch



HPL 6 mm-Aluminium - *HPL 6 mm-Alluminio* - HPL 6 mm-Aluminium



HPL 6 mm-Aluminium - *HPL 6 mm-Alluminio* - HPL 6 mm-Aluminium



SUNSET



Lac de Vouglans (39) - Plage du Surchauffant - France

ORIGINAL

SUNSET

CANNES

WESTPORT

INDEX

SUNSET

Bain de soleil - Lettino prendisole - Sonnenliegen



DURABLE
DUREVOLE
NACHHALTIG

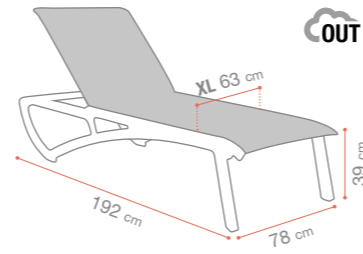

GREEN EDITION



Textile PVC - Tessuto in PVC - PVC-Textil

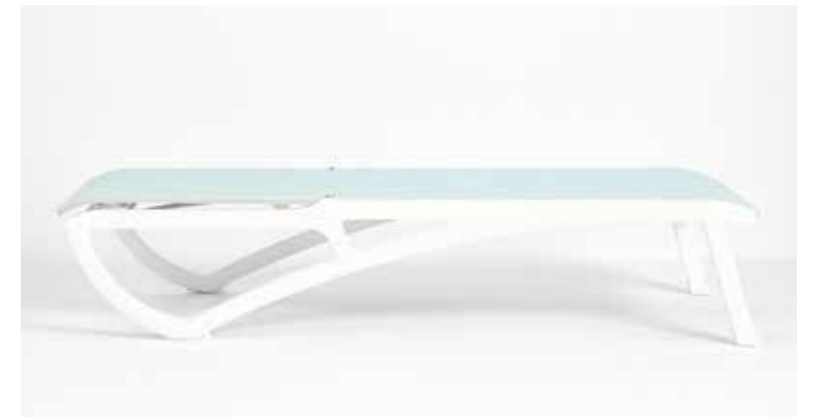

Composite high tech - Composito high tech
High-Tech-Komposit



ORIGINAL
SUNSET
CANNES
WESTPORT
INDEX

SUNSET

Tablette - Tavolozza centrale - Tablett

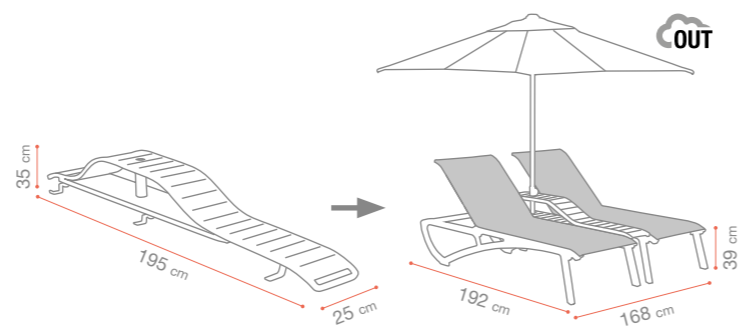

Aluminium - Alluminio - Aluminium





SUNSET

SUNSET

Conversationnel fauteuil - *Poltrona Relax Lounge* -
Lounge-Sessel

DURABLE
DUREVOLE
NACHHALTIG

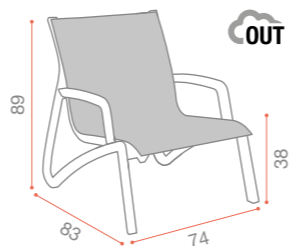
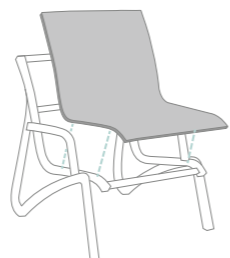

Textile PVC - *Tessuto in PVC* - PVC-Textil



Composite high tech
Composito high tech
High-Tech-Komposit



SUNSET

Conversationnel canapé - *Divano Lounge* -
Lounge-Sofa

DURABLE
DUREVOLE
NACHHALTIG

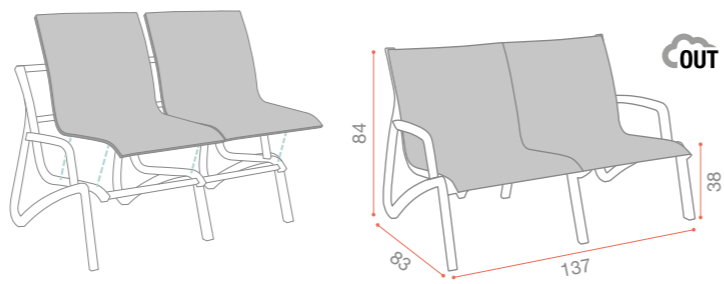

Composite high tech - *Composito high tech*
High-Tech-Komposit



Textile PVC - *Tessuto in PVC* - PVC-Textil



ORIGINAL
SUNSET
CANNES
WESTPORT
INDEX

SUNSET



- ORIGINAL
- SUNSET
- CANNES
- WESTPORT
- INDEX

SUNSET

Transat - Sdraio pieghevole - Faltliege

DURABLE
DUREVOLE
NACHHALTIG

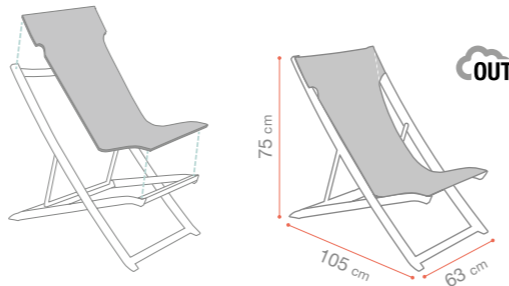

Composite high tech - *Composito high tech*
High-Tech-Komposit



Textile PVC - *Tessuto in PVC* - PVC-Textil



SUNSET



ORIGINAL

SUNSET

CANNES

WESTPORT

INDEX

SUNSET

Table basse carrée - *Tavolino quadrato*
Quadratischer niedrig Tabelle

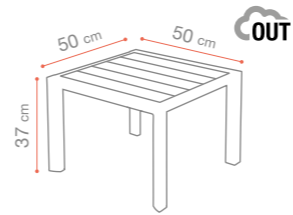

Aluminium - *Alluminio* - Aluminium

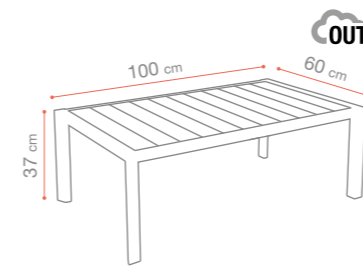

SUNSET

Table basse rectangulaire - *Tavolino rettangolare*
Rechteckiger niedrig Tabelle



Aluminium - *Alluminio* - Aluminium



ORIGINAL
SUNSET
CANNES
WESTPORT
INDEX

SUNSET

Towel valet Armoire de rangement - *Sistemazione asciugamani*
Lagerschrank

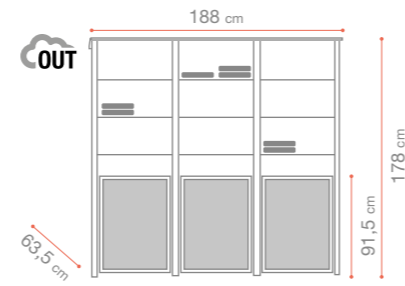

Aluminium - Alluminio - Aluminium



Textile PVC - Tessuto in PVC - PVC-Textil



SUNSET

Autour du monde - *Intorno al mondo* - Rund um die Welt

H10 vintage salou

SUNSET
H10 Vintage Salou *Salou - Espagne*



ORIGINAL
SUNSET
CANNES
WESTPORT
INDEX

SUNSET

Zé Barbudo Lounge *Porto Seguro - Brésil*



CATALONIA

- HOTELS & RESORTS -

Catalonia Hotel & Resort *Barcelone - Espagne*



ORIGINAL

SUNSET

CANNES

WESTPORT

INDEX

SUNSET

Hôtel Catalonia Costa Mujeres *Cancùn - Mexique*

CATALONIA

- HOTELS & RESORTS -

CATALONIA

- HOTELS & RESORTS -

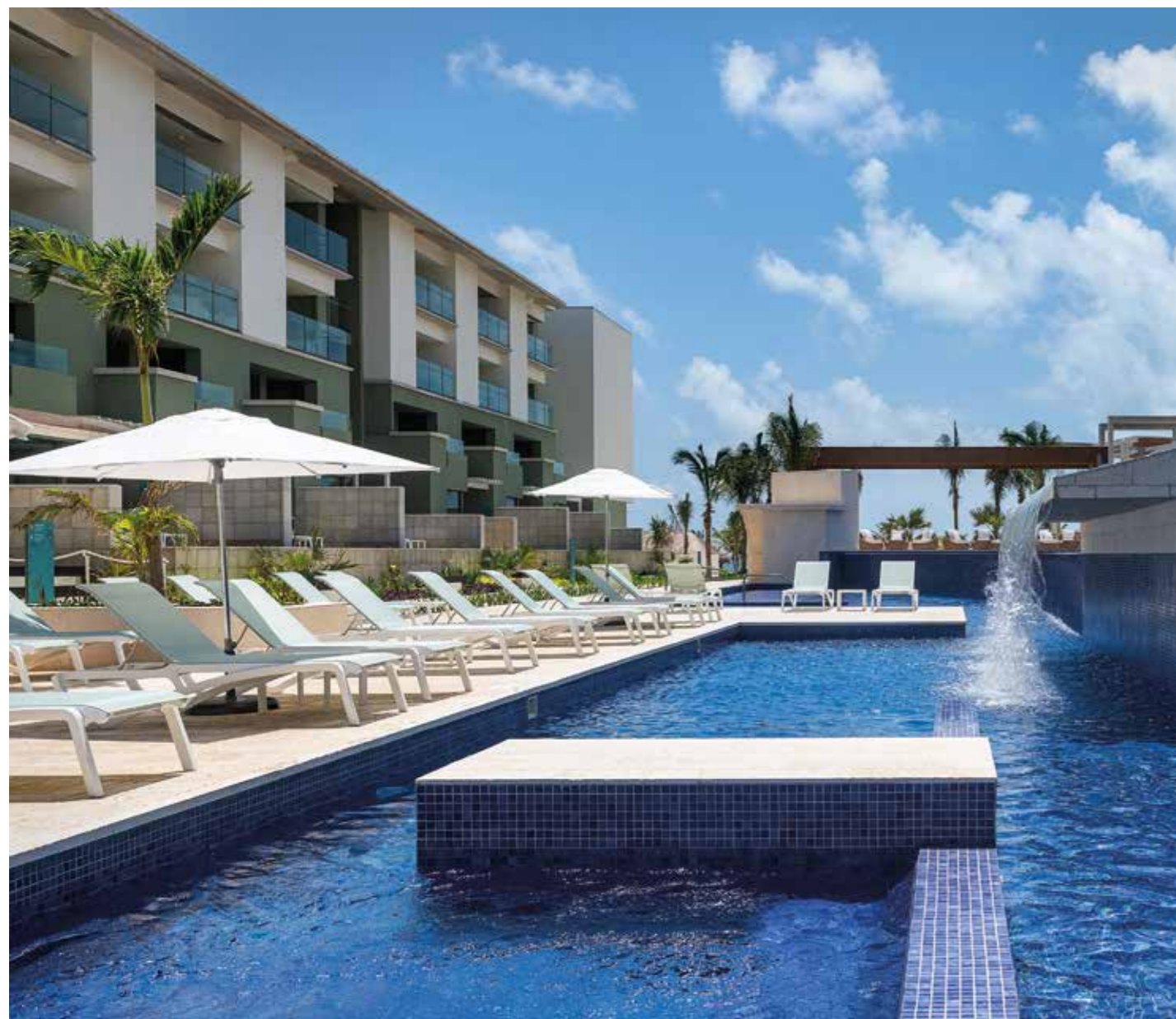

SUNSET

Voltraio Bio Resorts Volterra *Italy*



ORIGINAL
SUNSET
CANNES
WESTPORT
INDEX

SUNSET

Four Seasons Astir Palace Hotel *Vouliagmeni - Grèce*



SUNSET

Hôtel Manava Suite Resort Tahiti *Tahiti - France*



© MASSIMO COLOMBINI

Beach Bar *Knokke - Belgique*



ORIGINAL
SUNSET
CANNES
WESTPORT
INDEX

SUNSET

Saint Martin - Antilles



SUNSET

May Altafulla Beach Boutique Hotel *Altafulla - Espagne*



SUNSET

Beau Rivage Hôtel & Spa *Anncy - France*

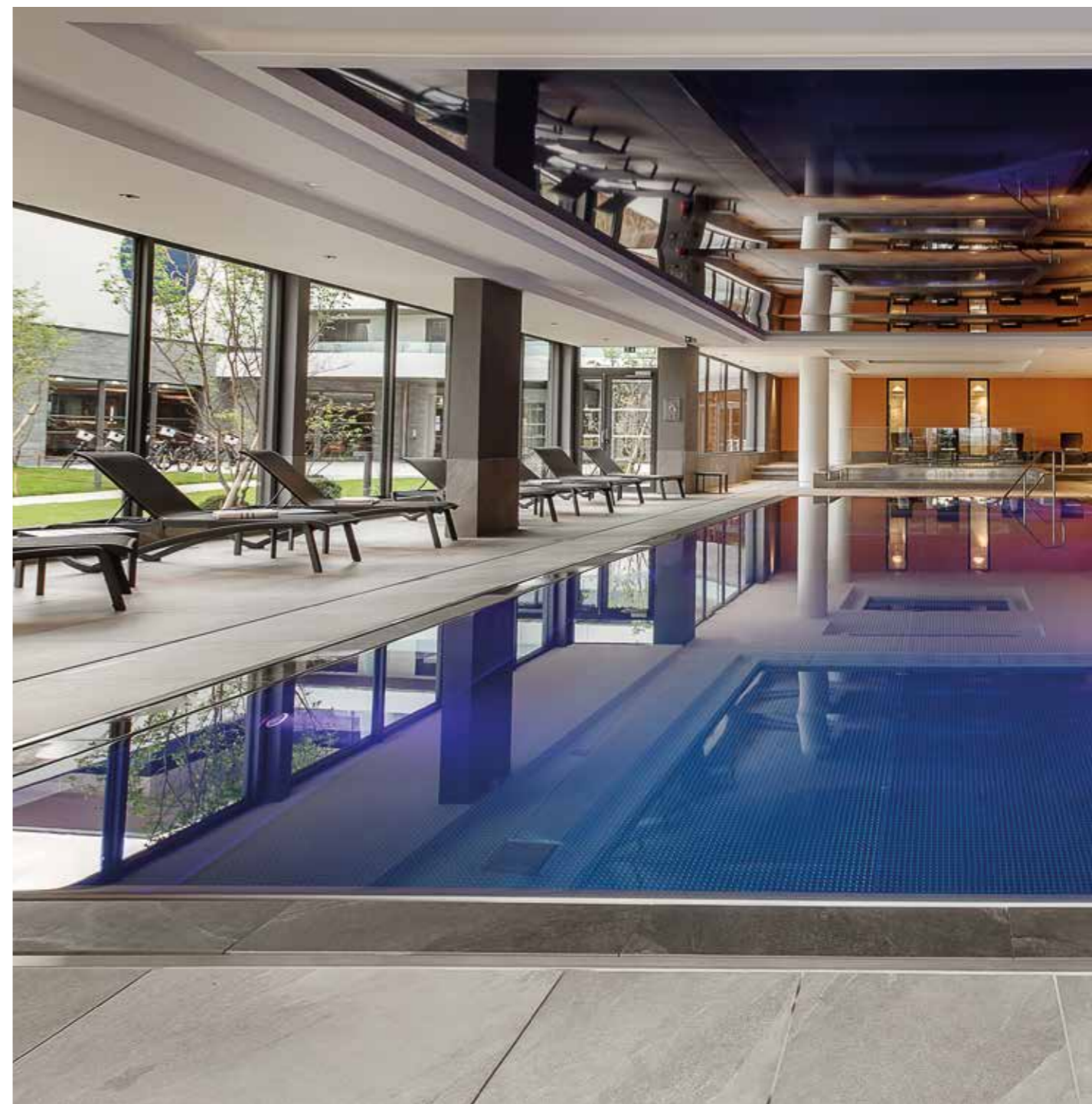

SUNSET

Europa Park Rust - Allemagne

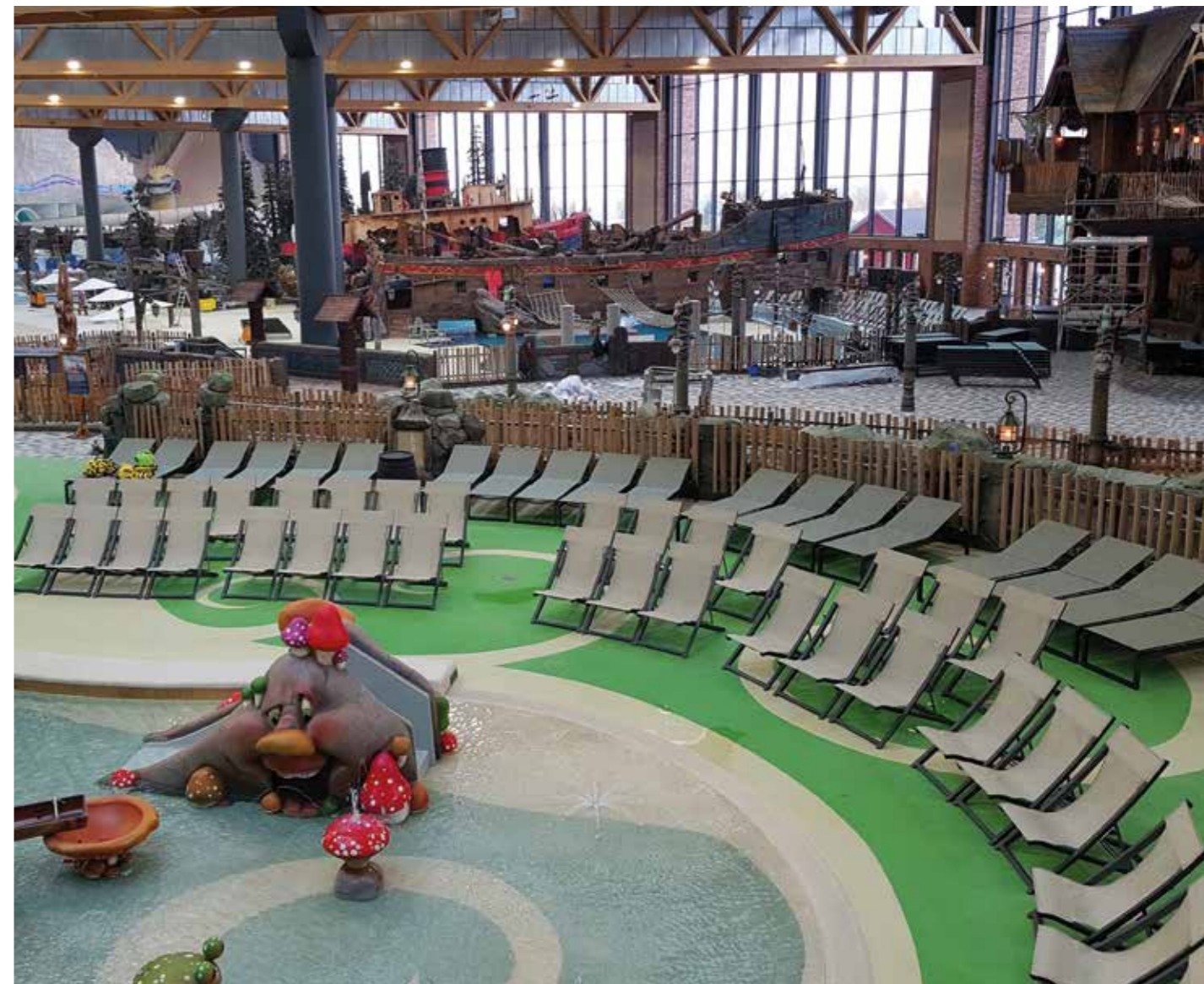

ORIGINAL

SUNSET

CANNES

WESTPORT

INDEX

SUNSET CONFORT

Hôtel & Spa - Les Bains d'Ovronnaz Ovronnaz - Suisse

SUNSET

ORIGINAL



© LALITA 74



© LALITA 74



© LALITA 74



© LALITA 74



© LALITA 74

SUNSET

CANNES

WESTPORT

INDEX

SUNSET CONFORT



SUNSET CONFORT

Hôtel Olympus Palace Salou - Espagne

HOTEL ★★★★★ SALOU
OLYMPUS PALACE

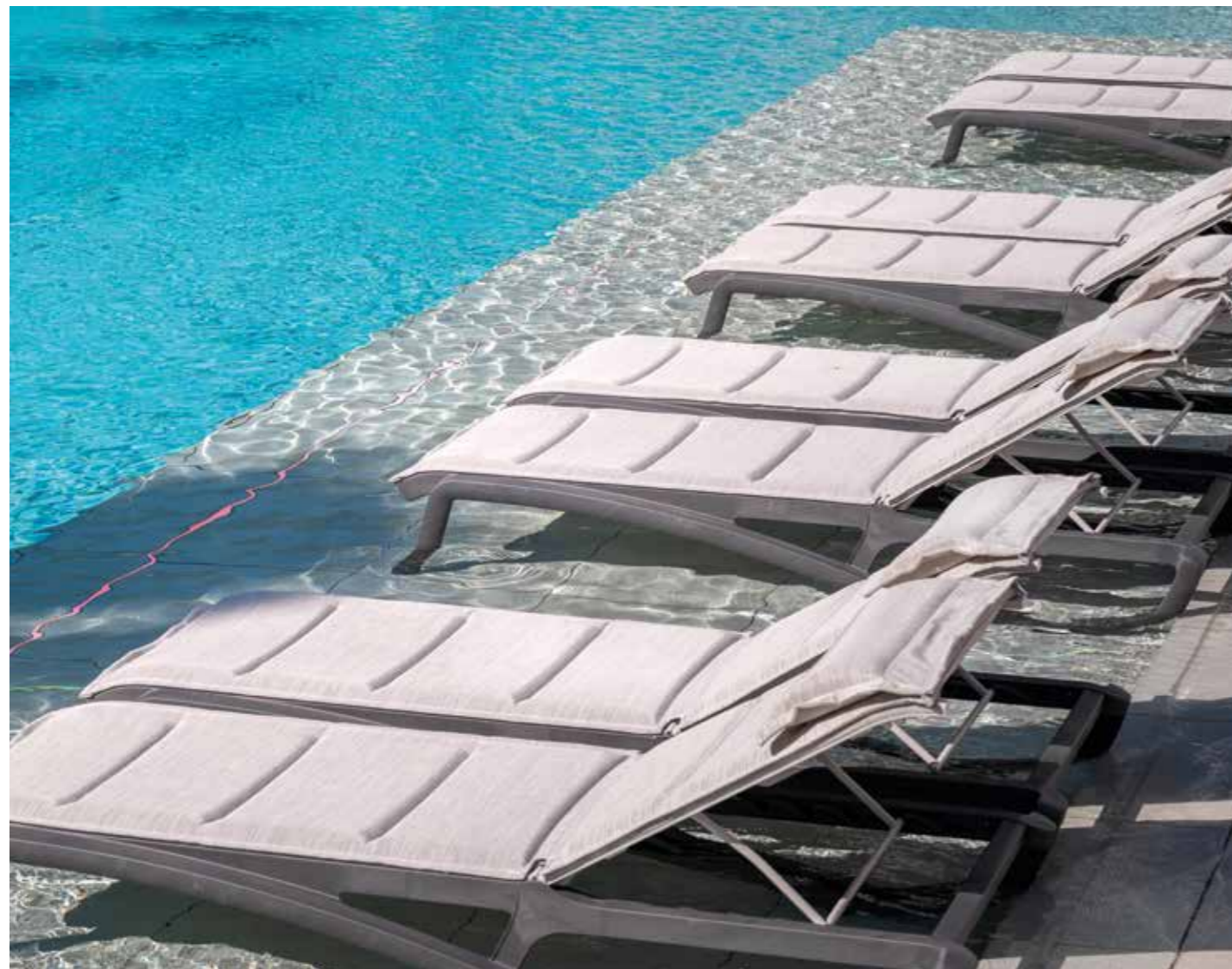

HOTEL ★★★★★ SALOU
OLYMPUS PALACE

SUNSET

Hôtel Olympus Palace Salou - Espagne

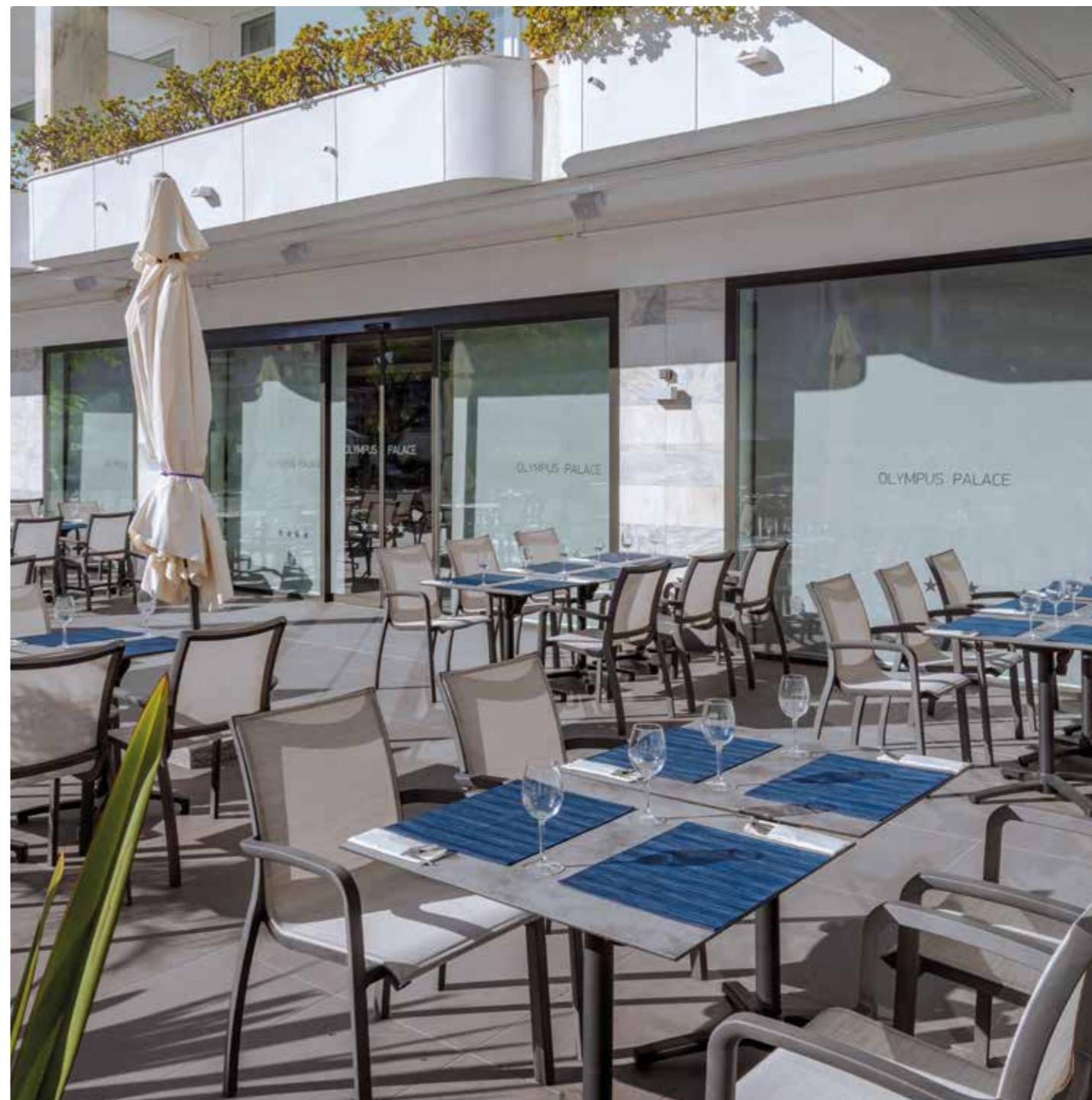

ORIGINAL

SUNSET

CANNES

WESTPORT

INDEX

SUNSET

Collection

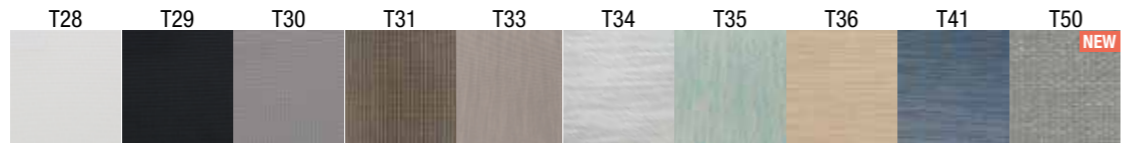

	T28	T29	T30	T31	T33	T34	T35	T36	T41	T50
		•			•		•			
			•	•	•			•		
				•						
					•					
										•
		•			•		•			
				•	•			•		

ECOLIBRIUM

SUNSET CONFORT

Collection



	T33	T34	T36	T41
		•		
			•	
				•
		•		

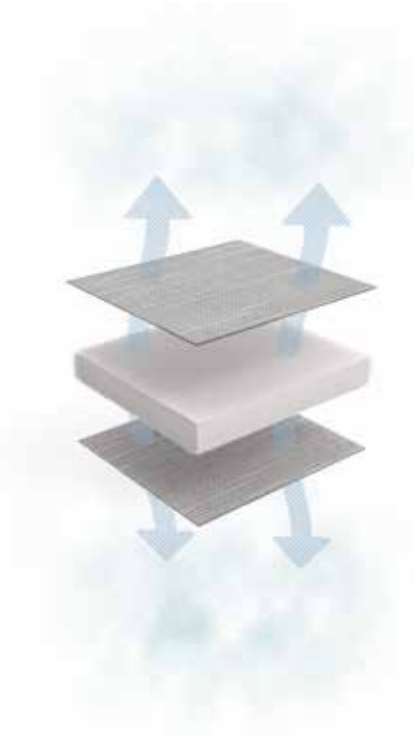

SUNSET

Déclinaison couleurs - *Colori disponibili* - Farbpalette

FAUTEUIL - POLTRONA - GARTENSESSEL

BLANC GLACIER
T28 BLANC



49 015 096

BLANC GLACIER
T33 BEIGE CHINÉ



49 027 096

BLANC GLACIER
T35 TURQUOISE CHINÉ



49 031 096

GRIS PLATINIUM
T30 GRIS



49 021 289

GRIS PLATINIUM
T33 BEIGE CHINÉ



49 027 289

NOIR VOLCANIQUE
T29 NOIR



49 008 288

NOIR VOLCANIQUE
T30 GRIS



49 021 288

NOIR VOLCANIQUE
T34 GRIS CHINÉ



49 028 288

BRONZE FUSION
T31 COGNAC



49 026 599

BRONZE FUSION
T36 BRUN CHINÉ



49 037 599

TABLES - TAVOLI - TISCH

BLANC
BLANC GLACIER



R4 101 096 + 55 729 096

GRIS CRYPTIC
GRIS PLATINIUM



R4 101 788 + 55 729 289

GRIS CRYPTIC
NOIR VOLCANIQUE



R4 101 788 + 55 729 288

BRUN CRYPTIC
BRONZE FUSION



R4 101 789 + 55 729 599

BLANC
BLANC GLACIER



R5 001 096 + 55 734 096

GRIS CRYPTIC
GRIS PLATINIUM



R5 001 788 + 55 734 289

GRIS CRYPTIC
NOIR VOLCANIQUE



R5 001 788 + 55 734 288

BRUN CRYPTIC
BRONZE FUSION



R5 001 789 + 55 734 599

CHAISE HAUTE - SGABELLO ALTO - HOHER BARSTUHL

BLANC GLACIER
T28 BLANC



34 300 096

GRIS PLATINIUM
T30 GRIS



34 301 289

NOIR VOLCANIQUE
T34 GRIS CHINÉ



R8 401 288

BRONZE FUSION
T31 COGNAC



34 302 599

ORIGINAL
SUNSET
CANNES
WESTPORT
INDEX

SUNSET

Déclinaison couleurs - *Colori disponibili* - Farbpalette

BAIN DE SOLEIL - LETTINI - SONNENLIEGEN



GREEN EDITION

NEW

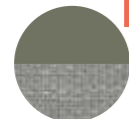

Q8 601 852

CONVERSATIONNELS - SALOTTO LOUNGE - NIEDRIGE SITZECKE



TABLES BASSES - TAVOLINI BASSI - KAFFEETISCHE

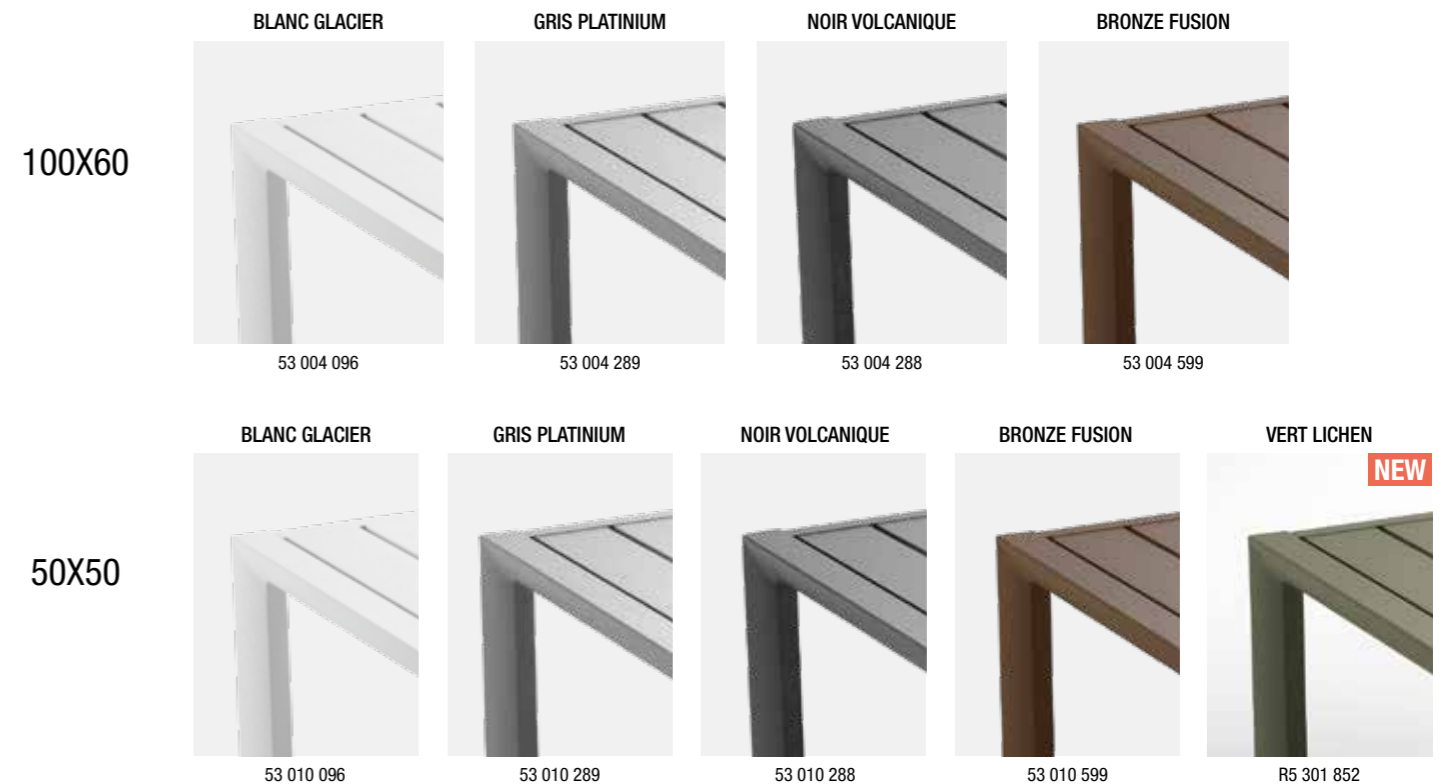

ORIGINAL
SUNSET
CANNES
WESTPORT
INDEX

SUNSET

Déclinaison couleurs - *Colori disponibili* - Farbpalette

TRANSAT - *SDRAIO PIEGHEVOLE* - FALTLIEGE

BLANC GLACIER
T28 BLANC



R7 705 096

BLANC GLACIER
T33 BEIGE CHINÉ



R7 709 096 *

BLANC GLACIER
T35 TURQUOISE CHINÉ



R7 707 096 *

GRIS PLATINIUM
T30 GRIS



R7 706 289

GRIS PLATINIUM
T33 BEIGE CHINÉ



R7 709 289

NOIR VOLCANIQUE
T30 GRIS



R7 706 288

NOIR VOLCANIQUE
T34 GRIS CHINÉ



R7 710 288

BRONZE FUSION
T36 BRUN CHINÉ



R7 708 599

TABLETTE - *TAVOLOZZA DI GIUNZIONE* - TABLET

BLANC GLACIER



53 005 096

GRIS PLATINIUM



53 005 289

NOIR VOLCANIQUE



53 005 288

BRONZE FUSION



53 005 599

SUNSET CONFORT

Déclinaison couleurs - *Colori disponibili* - Farbpalette

FAUTEUIL - *POLTRONA* - GARTENSESSEL

BLANC GLACIER
T33 BEIGE CHINÉ



U2 302 096

GRIS PLATINIUM
T33 BEIGE CHINÉ



U2 302 289

NOIR VOLCANIQUE
T34 GRIS CHINÉ



U2 301 288

BRONZE FUSION
T36 BRUN CHINÉ



U2 303 599

BAIN DE SOLEIL - *LETTINI* - SONNENLIEGEN

BLANC GLACIER
T33 BEIGE CHINÉ



R3 701 096

BLANC GLACIER
T41 BLEU MADRAS



R3 707 096

NOIR VOLCANIQUE
T34 GRIS CHINÉ



R3 706 288

BRONZE FUSION
T36 BRUN CHINÉ



R3 703 599

GRIS PLATINIUM
T33 BEIGE CHINÉ



R3 702 289

CONVERSATIONNELS - *SALOTTO LOUNGE* - NIEDRIGE SITZECKE

BLANC GLACIER
T33 BEIGE CHINÉ



1 PL U2 402 096
2 PL U2 502 096

GRIS PLATINIUM
T33 BEIGE CHINÉ



U2 402 289
U2 502 289

NOIR VOLCANIQUE
T34 GRIS CHINÉ



U2 401 288
U2 501 288

BRONZE FUSION
T36 BRUN CHINÉ



U2 403 599
U2 503 599

COLLECTION CANNES

ORIGINAL

SUNSET

CANNES

WESTPORT

INDEX



PLACE AUX BONS MOMENTS

Cette collection Cannes signe un hommage intemporel à tous les bons moments passés au café, en terrasse ou au restaurant, à ces lieux de vie où tout se passe, où l'on se retrouve seul à lire ou à regarder les gens passer, ces moments en amoureux où l'on se dit "je t'aime", ces moments en famille, entre amis où l'on fête la victoire de son club de foot, l'anniversaire d'un proche...

Ces moments sont ce que nous avons de plus précieux, véritables marqueurs de nos souvenirs, ils racontent notre histoire.

SPAZIO AI BEI MOMENTI

Questa collezione Cannes dedica un omaggio senza tempo a tutti i bei momenti trascorsi al bar, sulla terrazza o al ristorante, a quei luoghi di vita dove tutto accade, dove ci si ritrova da solo a leggere o a guardare la gente che passa, a quei momenti in coppia dove ci si dice "ti amo", a quei momenti in famiglia, tra amici dove si festeggia la vittoria della propria squadra del cuore, il compleanno di un parente...

Questi momenti sono ciò che abbiamo di più prezioso, veri e propri segnaposto dei nostri ricordi, raccontano la nostra storia.

ZEIT FÜR SCHÖNE MOMENTE

Diese Kollektion Cannes ist eine zeitlose Hommage an all die schönen Momente, die wir in Straßencafés, auf Bistrotterrassen oder im Restaurant verbracht haben, an diesen so lebendigen Orten, wo sich das Leben abspielt, wo man entweder alleine in einem Buch schmökert oder den Passanten nachschaut, diese Momente der Verliebtheit mit einem gehauchten „Ich liebe dich“, diese Momente mit der Familie, unter Freunden, wenn man den Sieg seines Fußballvereins oder den Geburtstag einer lieben Person feiert ...

Diese Momente sind das Wichtigste was wir haben, die uns bleibenden Erinnerungen, sie erzählen die Geschichte unseres Lebens.



CANNES

ORIGINAL

SUNSET

CANNES

WESTPORT

INDEX

NEW

SOFA CANNES

Set 4 places & table basse
Set 4 posti e tavolino
Set 4 Plätze & Couchtisch

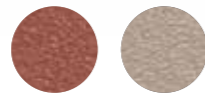
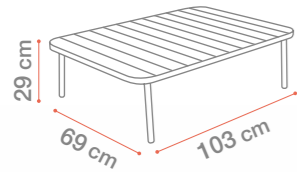
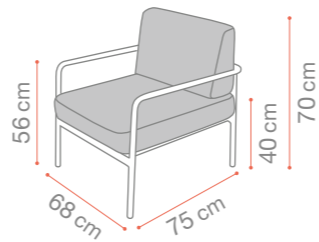
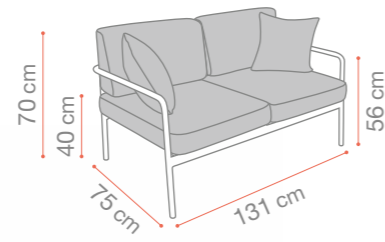

Aluminium - Alluminio - Aluminium

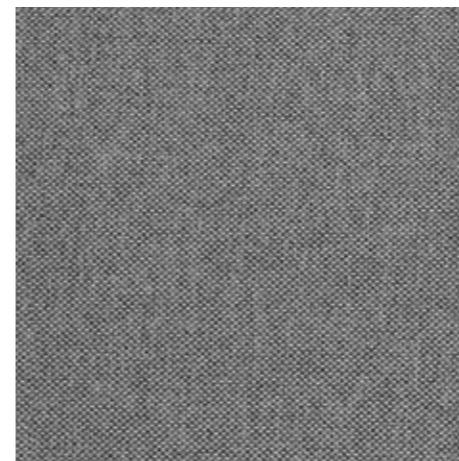

Gris Chiné

100% Oléfine teinté masse
100% Olefin colorato nella massa
100% spinnfärbtes Olefin

ORIGINAL
SUNSET
CANNES
WESTPORT
INDEX

CANNES



Le Grau-du-Roi (30) - Plage du Miramar - France

ORIGINAL

SUNSET

CANNES

WESTPORT

INDEX

CANNES

Chaise & Fauteuil - Sedia & Poltrona - Stuhl & Sessel

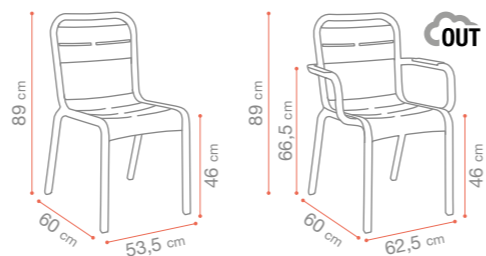

Fiber glass
Polypropylène - Polipropilene - Polypropylen



NEW

CANNES

Tabouret de bar - *Sgabello* - Barstuhl



Fiber glass
Polypropylène - Polipropilene - Polypropylen



ORIGINAL

SUNSET

CANNES

WESTPORT

INDEX

CANNES



Saint-Cyr-sur-Mer (83) - Plage de la Madrague - France

ORIGINAL

SUNSET

CANNES

WESTPORT

INDEX

NEW

CANNES

Table - Tavola - Tisch

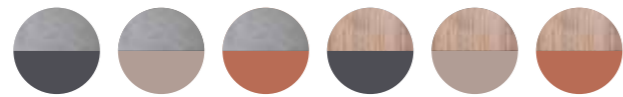
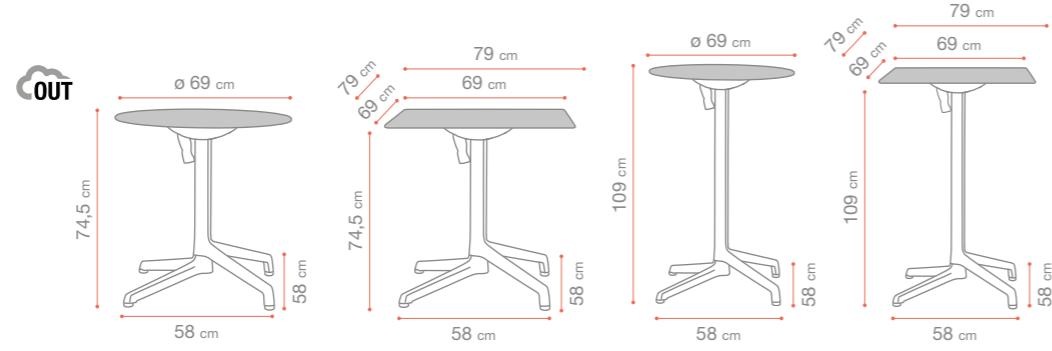

Fiber glass
Polypropylène - Polipropilene - Polypropylen



Grosfillex system



Aluminium - Alluminio - Aluminium



HPL 10 mm



ORIGINAL

SUNSET

CANNES

WESTPORT

INDEX

CANNES



ORIGINAL

SUNSET

CANNES

WESTPORT

INDEX

CANNES

Table extensible - *Tavolo allungabile* - Ausziehtisch

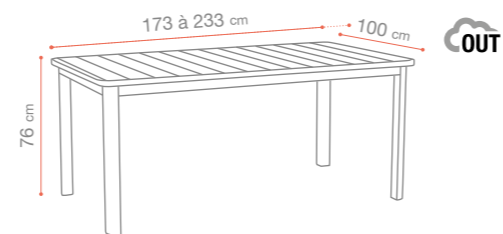

Aluminium - *Alluminio* - Aluminium



CANNES

Autour du monde - *Intorno al mondo* - Rund um die Welt

CANNES

Restaurant Le Miramar *La Grande-Motte - France*



© STÉPHANE COUCHET

ORIGINAL

SUNSET

CANNES

WESTPORT

INDEX

CANNES



CANNES

Restaurant Le Classico *Palavas les Flots - France*





© STÉPHANE COUCHET



CANNES

Restaurant L'Atelier des Cousins *La Rochelle - France*



Rivage Hôtel & Spa *Anncy - France*



ORIGINAL

SUNSET

CANNES

WESTPORT

INDEX

CANNES

Barawine & more *Nyon - Suisse*



Vienne - Autriche



ORIGINAL

SUNSET

CANNES

WESTPORT

INDEX

CANNES

OHITELS *Mazagon - Espagne*



COLLECTION WESTPORT

ORIGINAL

SUNSET

CANNES

WESTPORT

INDEX

WESTPORT

ADIRONDACK Fauteuil - Poltrona Relax - Sessel

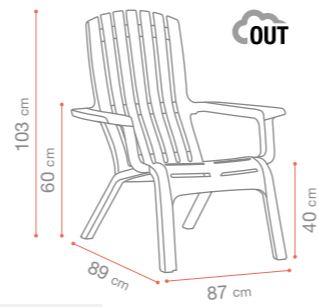

Polypropylène - Polipropilene - Polypropylen



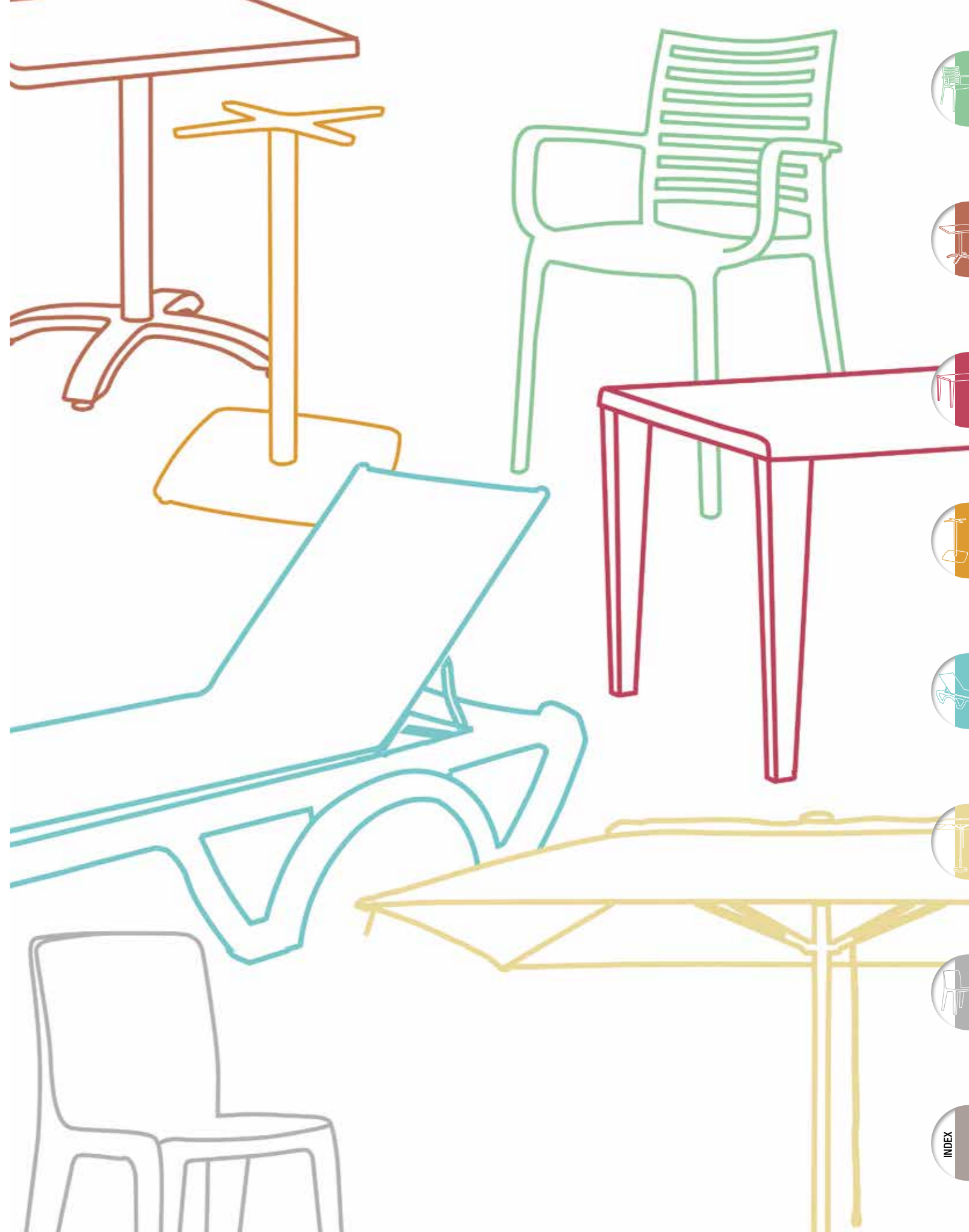

SOMMAIRE - INDICE - ÜBERSICHT

CHAISES & FAUTEUILS OUTDOOR
SEDIE E POLTRONE OUTDOOR
STUHL & SESSEL OUTDOOR



TABLES, PIEDS & PLATEAUX OUTDOOR
TAVOLI, BASAMENTI E PIANI OUTDOOR
TISCHE, TISCHGESTELLE UND OUTDOOR-TISCHPLATTEN



GRANDES TABLES
TAVOLI GRANDI
GROSSE TISCHE



RESTAURATION INDOOR
RISTORAZIONE INTERNA
INNENRESTAURIERUNG



BAINS DE SOLEIL
LETTINI PRENDISOLE
SONNENLIEGEN



PARASOLS
OMBRELLONI
SONNENSCHIRME



LES COLLECTIVITÉS
COLLETTIVITÀ
KOMMUNEN



INDEX
INDICE
INDEX



OUTDOOR
CHAISES & FAUTEUILS
SEDIE E POLTRONE
STUHL & SESSEL



MOON



Charix (01) - Lac Genin - France



MOON

Chaise & Fauteuil - *Sedia & Poltrona* - Stuhl & Sessel

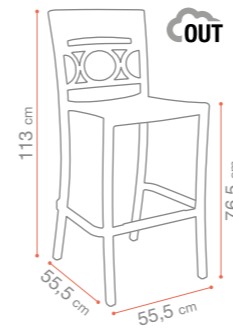
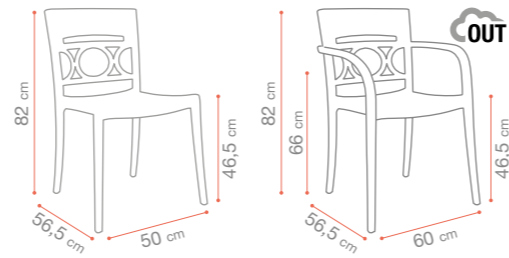

Fiber glass
Polypropylène - *Polipropilene* - Polypropylen

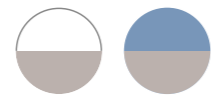

MOON

Chaise haute - *Bar high chair* - Barstool

Fiber glass
Polypropylène - *Polipropilene* - Polypropylen



Aluminium - *Aluminio* - Aluminium

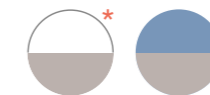

* Dans la limite des stocks disponibles * *Serie limitata* * Solange der Vorrat reicht

SLAT



Arbent (01) - Usine Grosfillex La Plaine - France



NEW

SLAT

Chaise & Fauteuil - Chair & Armchair
Stoel & Stoel met armleuning

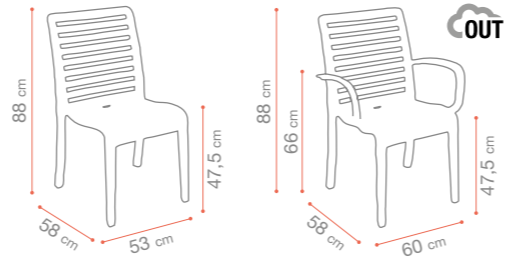

Polypropylène - Polipropilene - Polypropylen



VÉGÉTAL



VÉGÉTAL

Chaise & Fauteuil - *Sedia & Poltrona* - Stuhl & Sessel

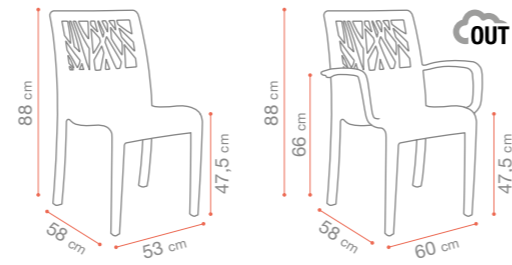

Polypropylène - *Polipropilene* - Polypropylen



INDEX



TULIPE



TULIPE

Chaise & Fauteuil - *Sedia & Poltrona* - Stuhl & Sessel

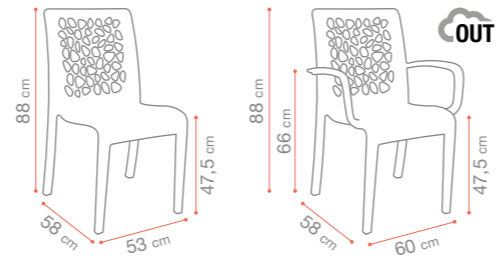

Polypropylène - *Polipropilene* - Polypropylen





FACTORY

Chaise & Fauteuil - *Sedia & Poltrona* - Stuhl & Sessel

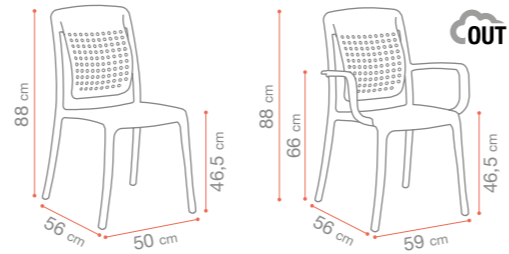

Fiber glass
Polypropylène - *Polipropilene* - Polypropylen



SUNDAY



SUNDAY

Chaise & Fauteuil - *Sedia & Poltrona* - Stuhl & Sessel

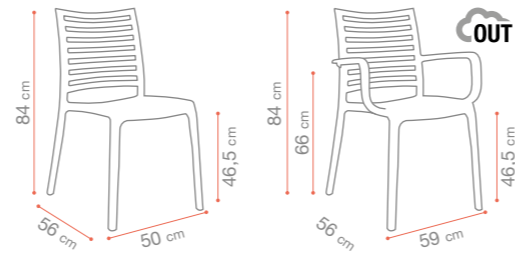

Fiber glass
Polypropylène - *Polipropilene* - Polypropylen



INDEX



CLIP

Chaise - Sedia - Stuhl



Polypropylène - Polipropilene - Polypropylen



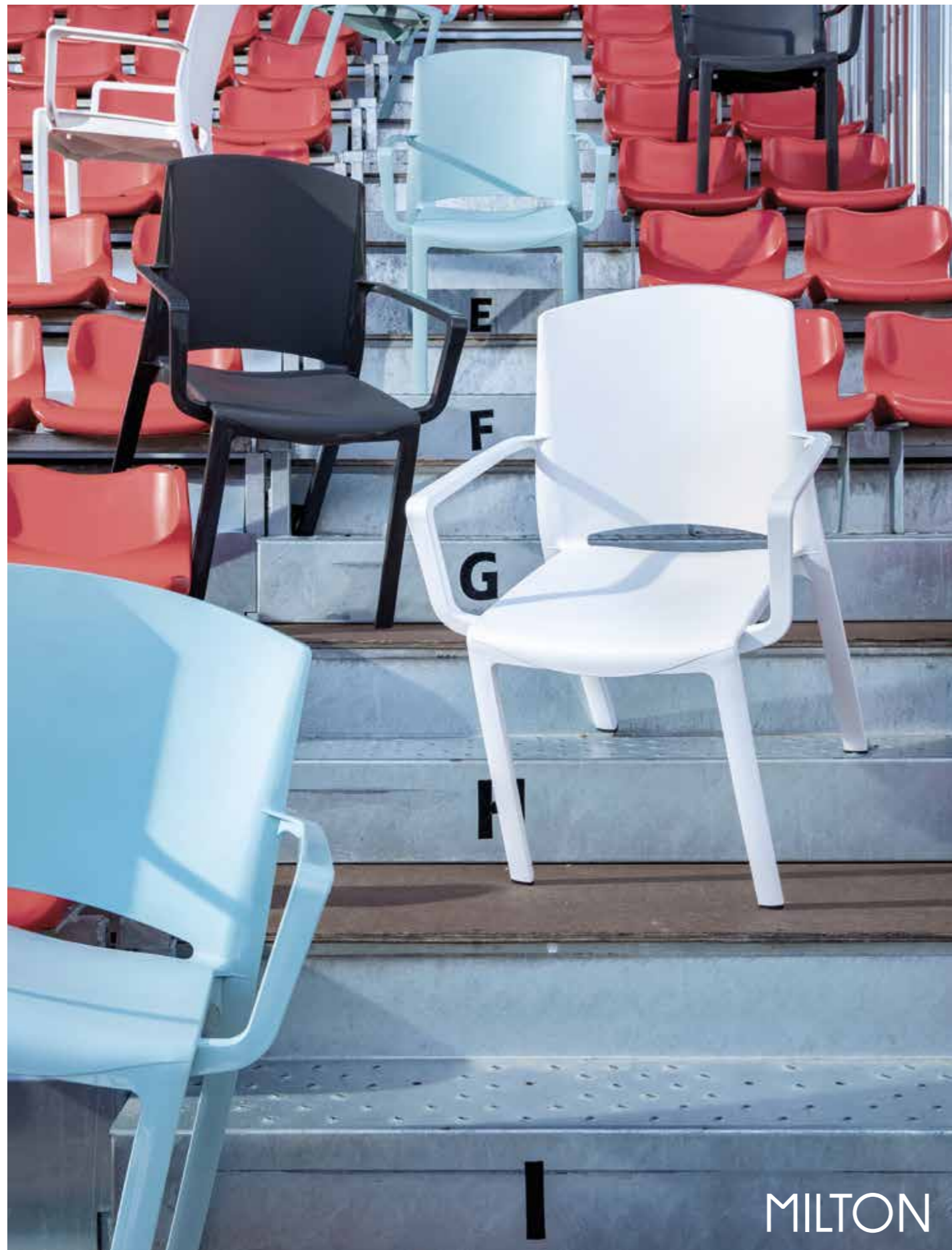

MILTON

Fauteuil - Poltrona - Sessel

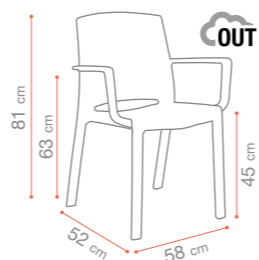

Polypropylène - Polipropilene - Polypropylen

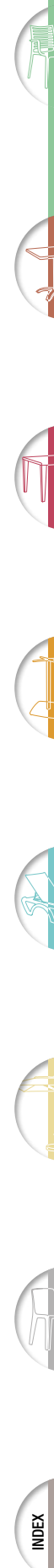

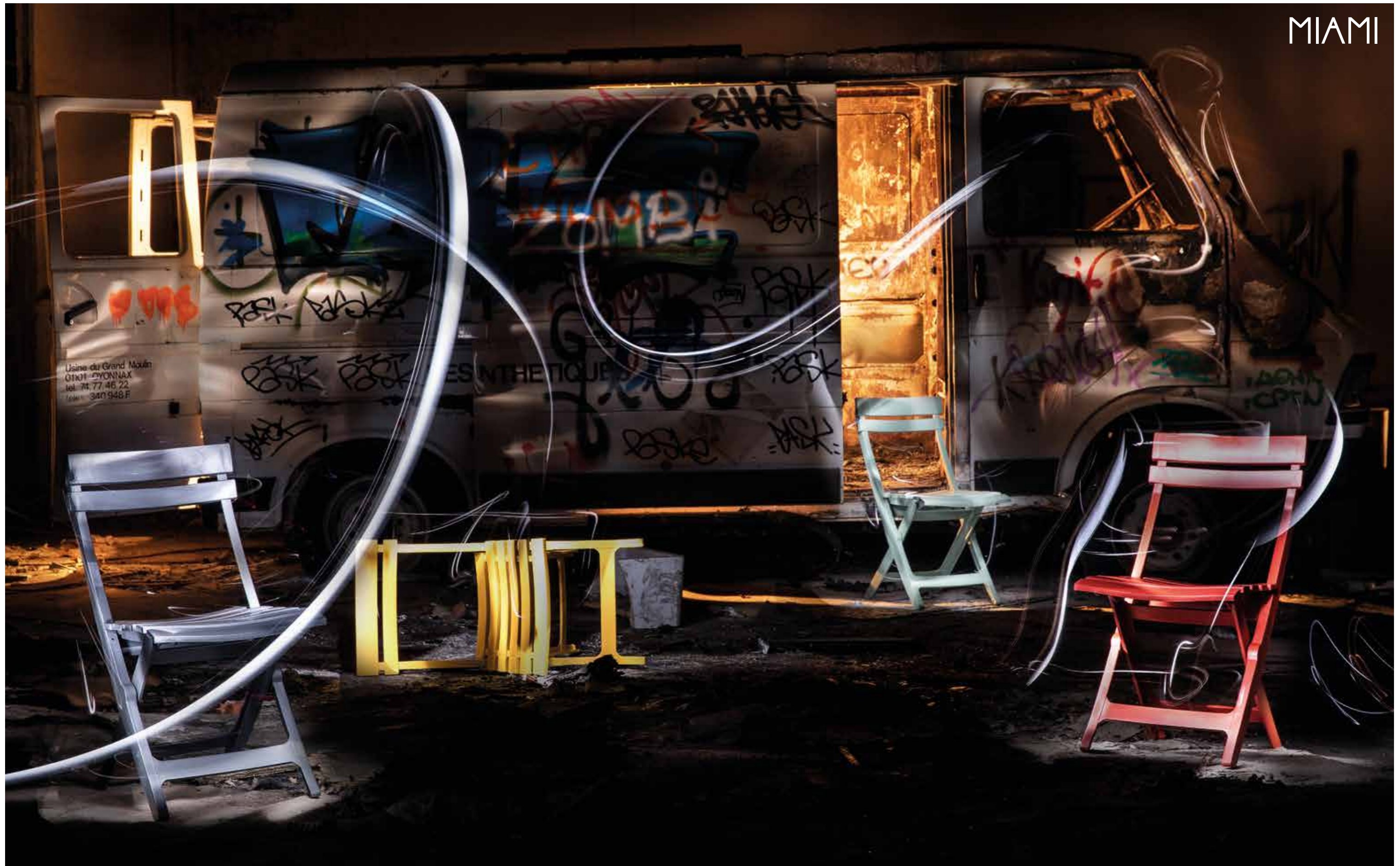

Usine du Grand Moulin
01101 OYONNAX
tel. 74 77 46 22
fax 340 948 F

ESNTHETIQUE

OMPA



MIAMI

Chaise pliante - *Sedia pieghevole* - Klappstuhl



Polypropylène - *Polipropilene* - Polypropylen



MIAMI BISTROT

Chaise - Sedia - Stuhl

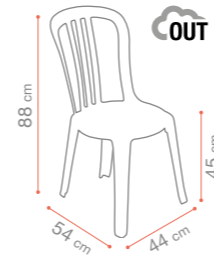

Polypropylène - Polipropilene - Polypropylen



INDEX

**TABLES, PIEDS & PLATEAUX
OUTDOOR**

*TAVOLI, BASAMENTI E PIANI
OUTDOOR*

**TISCHE, TISCHGESTELLE UND
OUTDOOR-TISCHPLATTEN**





NEW

QUATTRO

Pied auto-stabilisant

Basamento autolivellante per tavoli

Selbst-stabilisierendes Tischgestell

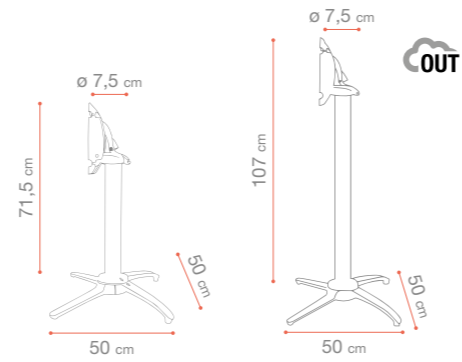

Système auto-stabilisant jusqu'à 2 cm
 Sistema autostabilizzante (corregge fino a 2 cm di dislivello)
 Selbst-stabilisierendes System bis zu 2 cm



Pied en aluminium laqué, encastrable & rabattable
 Base in alluminio ribaltabile ad incastro
 Lackiertes Aluminiumgestell mit Nesting- und Klappsystem



Grosfillex system

NEW

X2.O

Pied rabattable
Basamenti ribaltabili
Klappbares Tischgestell

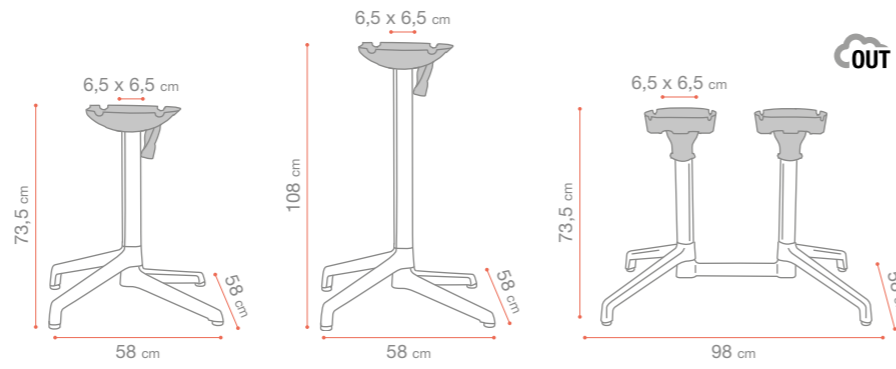

Fiber glass
Polypropylène - Polipropilene - Polypropylen



Grosfillex system



Aluminium - Alluminio - Aluminium



INDEX

XONE

Pied rabattabile
Basamenti ribaltabili
Klappbares Tischgestell

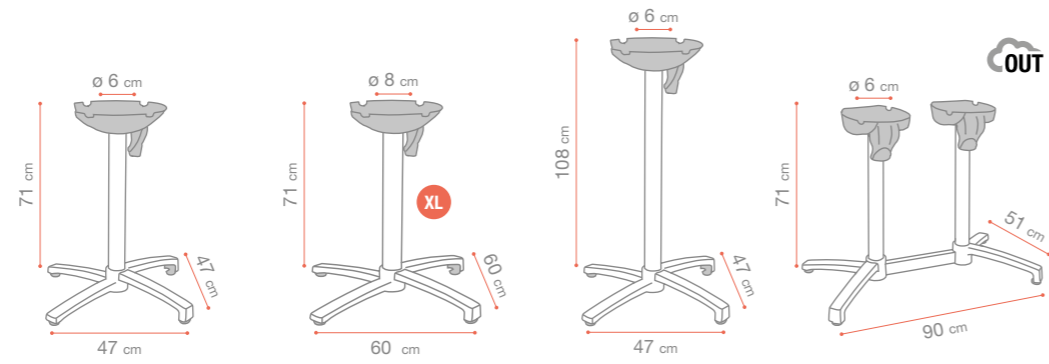

Aluminium - Alluminio - Aluminium



Grosfillex system



TETRA

Pied de table - *Gamba del tavolo* - Tischgestell

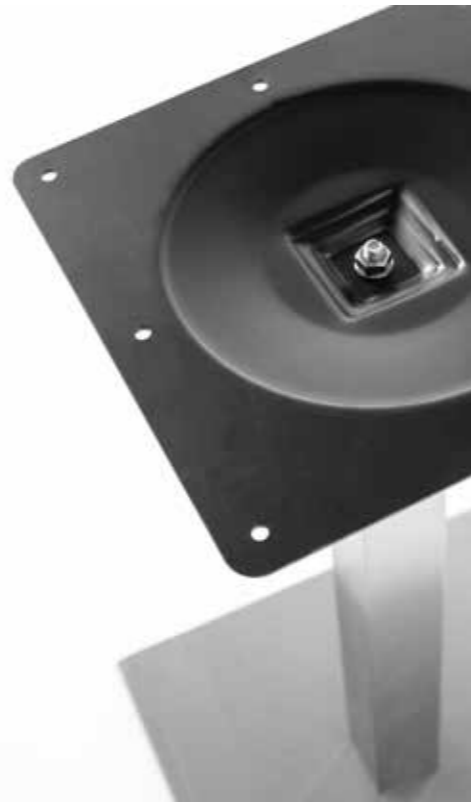
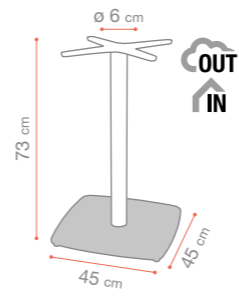
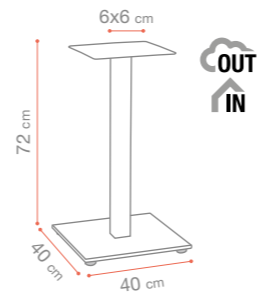

Acier avec traitement par cataphorèse
Acciaio con verniciatura per cataforesi
Stahl Durch Kataphorese

Inox - *Acciaio inox* - Inox



DOMOS

Pied de table - *Gamba del tavolo* - Tischgestell



ECOFIX

Pied de table - *Gamba del tavolo* - Tischgestell

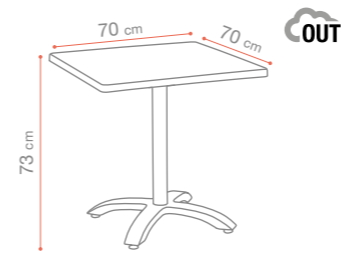
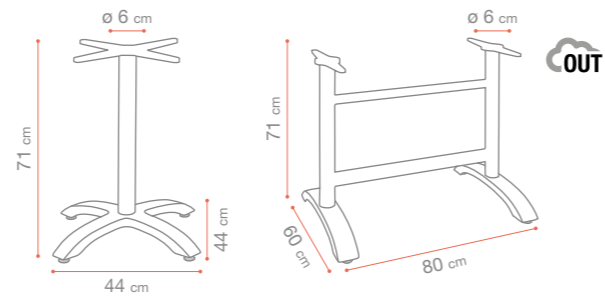

ECOFIX

Table - *Tavolo* - Tisch



Plateau SEVELIT® - *Piano melaminico SEVELIT®*
Platten SEVELIT®



Aluminium laqué - *Alluminio laccato* - Lackiertes Aluminium

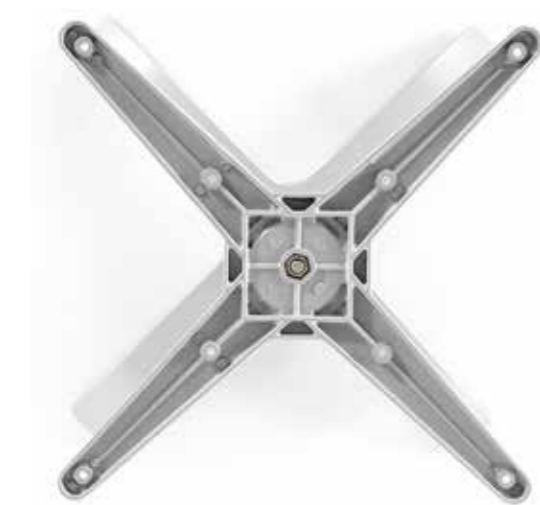

Aluminium - *Alluminio* - Aluminium



27 mm



INDEX

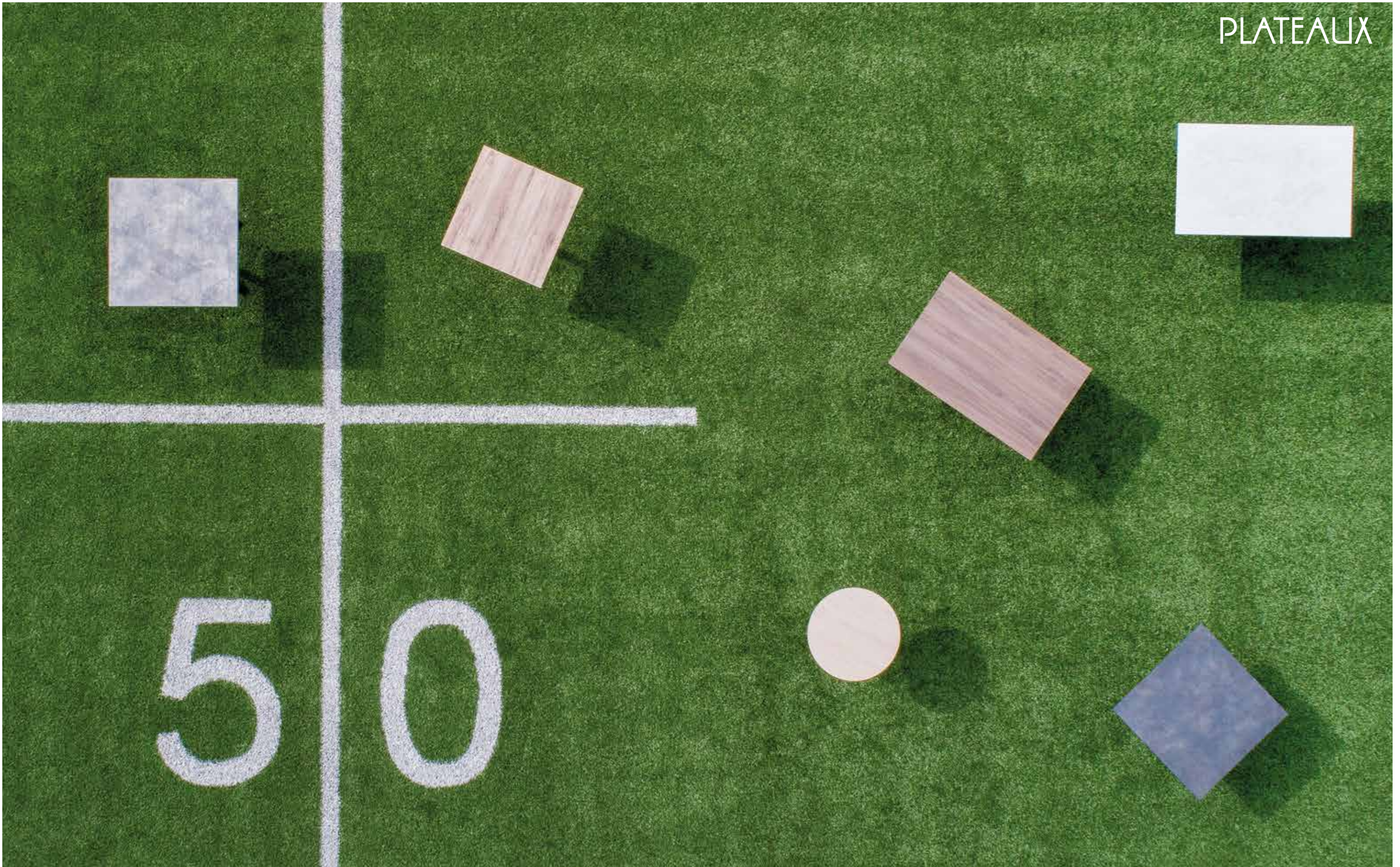

NEW

IPAN IPAN

Chargeur universel sans fil & ports USB - *Sistema di ricarica universale sia USB che senza filo* -
Universelles kabelloses Ladegerät mit USB-Ports



Battery pack
Stick & charge



Chargeur sans fil - *Ricarica per induzione (senza filo)* - Kabelloses Ladegerät

Ports USB - *Porti USB* - USB-Ports



Certifié IP 65 (étanchéité)
Certificato IP65 (Resistente all'acqua piovana)
Zertifiziert nach IP 65 (regenfest)

Système antivol (avec clé de sécurité magnétique)
Sistema antifurto grazie ad una chiavetta magnetica
Anti-Diebstahl-System (mit magnetischem
Sicherheitsschlüssel)



COMPACTS

Plateau de table
Piano del tavolo
Tischplatte

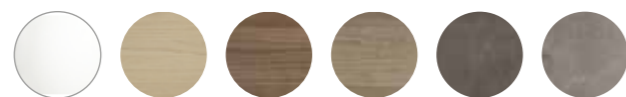
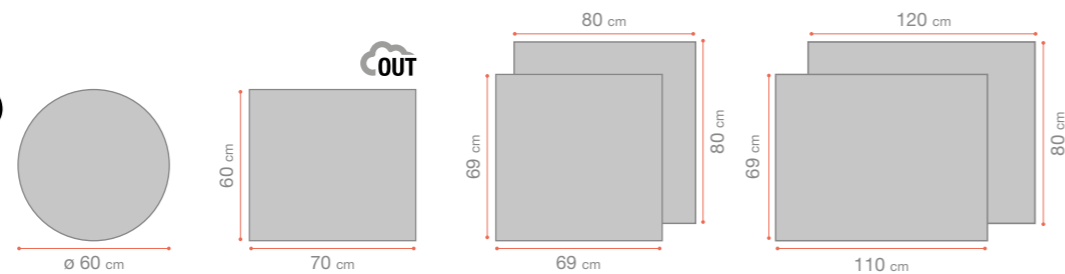

HPL 10 mm



INDEX

EXTERIOLIT

Plateau de table - *Piano del tavolo* - Tischplatte

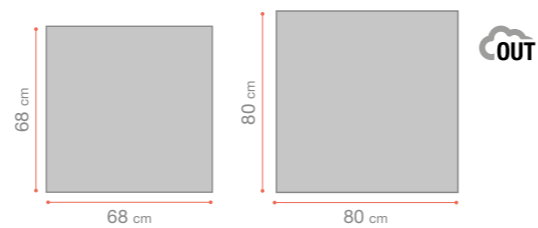

-
- HPL 1,2 mm
 - Contreplaqué - Colle tenue extérieur
 - Aglomerato alta pressione - Colla marina per esterno
 - Sperrholz - Wasserfest verleimt
 - HPL 1,2 mm



GRANDES TABLES

TAVOLI GRANDI

GROSSE TISCHE





GREGGIA



Arbent (01) - La Plaine, site de production Grosfillex - France



GREGGIA

Table - *Tavolo* - Tisch

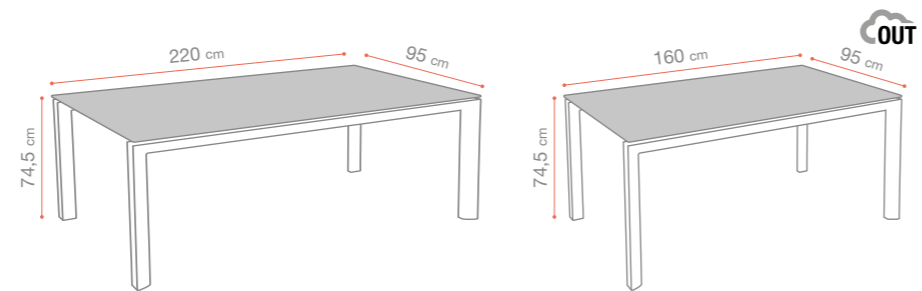

Aluminium - *Alluminio* - Aluminium

HPL Béton Touch 10 mm



160 cm



ALPHA

Nantua (01) - Lac de Nantua - France



ALPHA

Table - *Tavolo* - Tisch

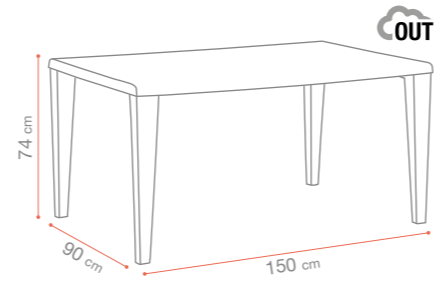

Polypropylène - Polipropilene - Polypropylen



GRANDES TABLES *TAVOLI GRANDI* GROSSE TISCHE

Autour du monde - *Intorno al mondo* - Rund um die Welt



RESTAURATION INDOOR
RISTORAZIONE INTERNA
INNENRESTAURIERUNG





COLOR TOP

COLOR TOP

Plateau de table intérieur - *Piano tavolo per interni*
Tischplatten für den Innenbereich

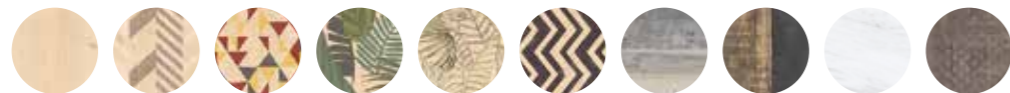
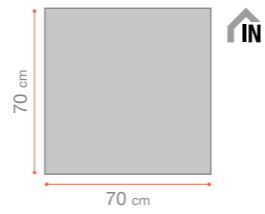

28 mm



INDEX

LAMIDUR

Plateau de table intérieur - *Piano tavolo per interni*
Tischplatten für den Innenbereich

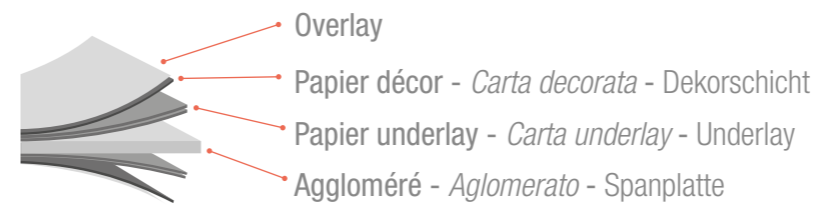
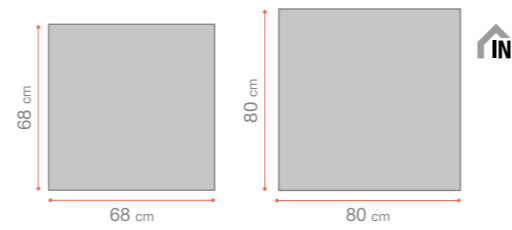

25 mm



RESTAURATION INDOOR *RISTORAZIONE INTERNA* INNENRESTAURIERUNG

Autour du monde - Interno al mondo - Rund um die Welt



COLOR TOP & DOMOS



BAINS DE SOLEIL
LETTINI PRENDISOLE
SONNENLIEGEN



BALI & BALI CONFORT



INDEX

BALI CONFORT

Bain de soleil - *Lettini* - Sonnenliegen

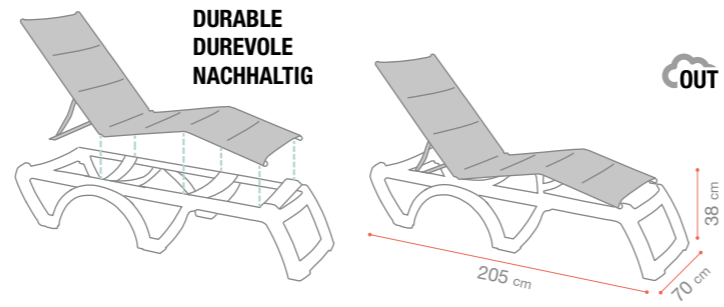

Textile PVC - *Tessuto in PVC* - PVC-Textil

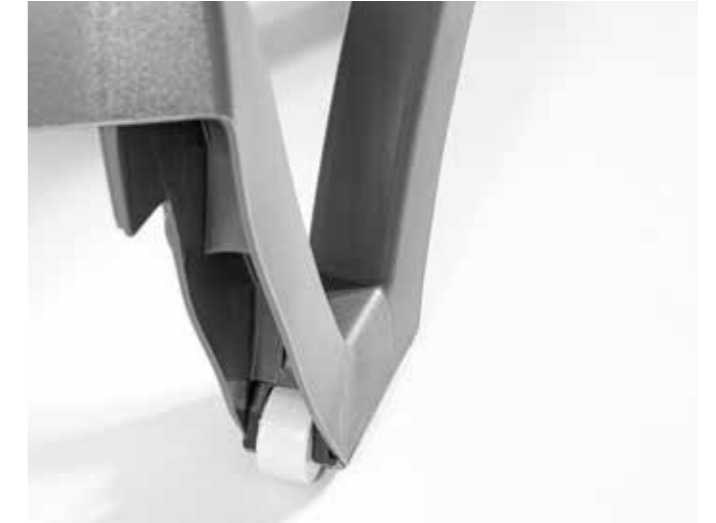

Polypropylène - *Polipropilene* - Polypropylen



Aluminium - *Alluminio* - Aluminium



INDEX

BALI

Bain de soleil - *Lettini* - Sonnenliegen

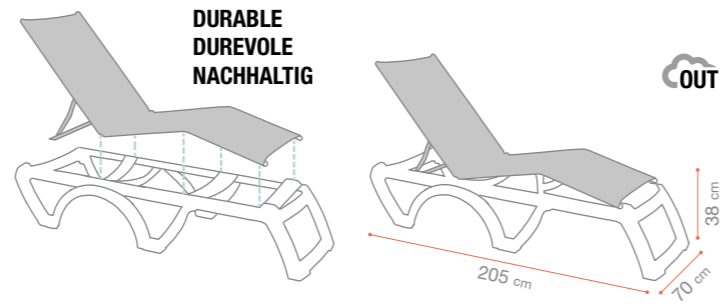

Textile PVC - *Tessuto in PVC* - PVC-Textil



Polypropylène - *Polipropilene* - Polypropylen



Aluminium - *Alluminio* - Aluminium

INDEX



JAMAICA BEACH



JAMAICA BEACH

Bain de soleil - Lettini - Sonnenliegen

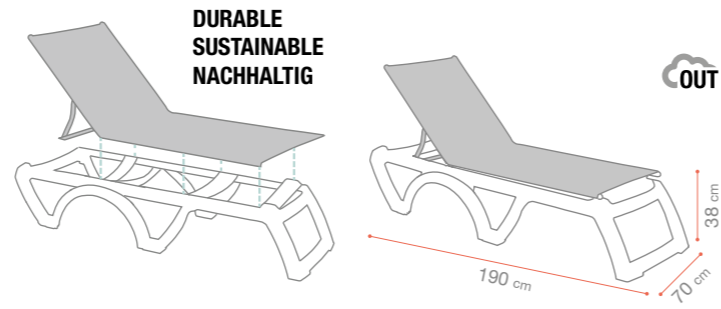

Textile PVC - Tessuto in PVC - PVC-Textil



Aluminium - Alluminio - Aluminium



Polypropylène - Polipropilene - Polypropylen



MIAMI

Bain de soleil - *Lettini* - Sonnenliegen

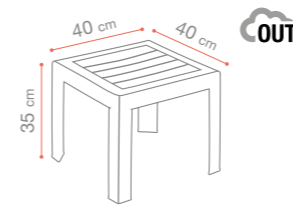
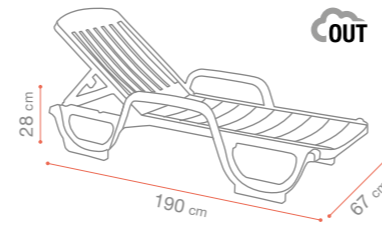

MIAMI

Table basse - *Tavolino basso* - Niedrig Tabelle



Polypropylène - *Polipropilene* - Polypropylen



Polypropylène - *Polipropilene* - Polypropylen



BAINS DE SOLEIL *LETTINI PRENDISOLE* SONNENLIEGEN

Autour du monde - *Intorno al mondo* - Rund um die Welt



JAMAICA BEACH

H10 Rubicon Palace *Lanzarote - Espagne*



Domaine de Sévenier Lagorce *Lagorce - France*



JAMAICA

Hotel Mongibello *Ibiza*



INDEX

JAMAICA

Praia Salgados *Albufeira - Portugal*



Praia das Pedras Amarelas *Galé - Portugal*



JAMAICA

Hotel Pestana Palace *Lisboa - Portugal*



MIAMI

Tropicana *France*



PARASOLS
OMBRELLONI
SONNENSCHIRME



PARASOLS

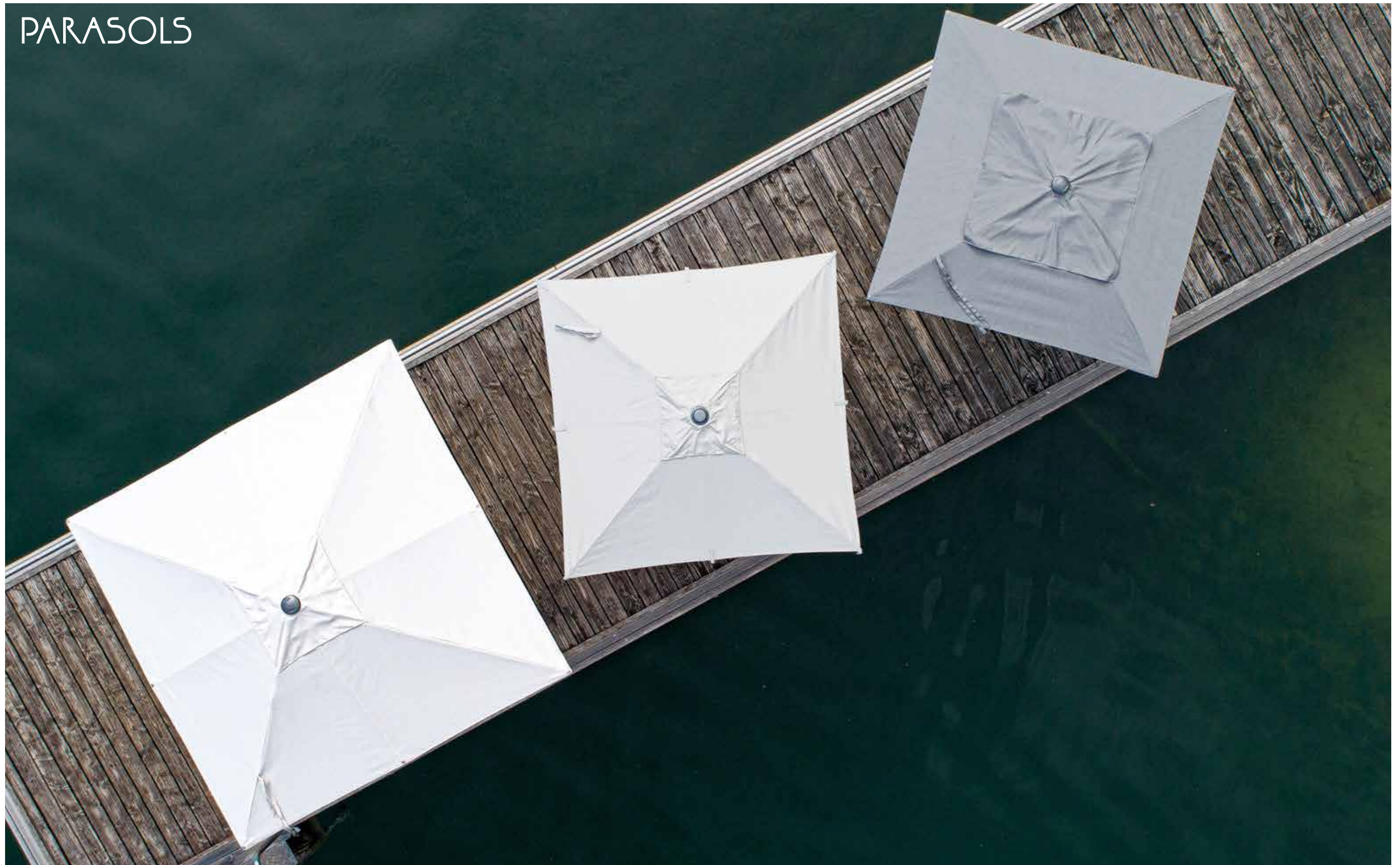

GREENWICH

Parasol carré - *Ombrellone quadrato* - Eckiger Sonnenschirm
250 x 250 cm

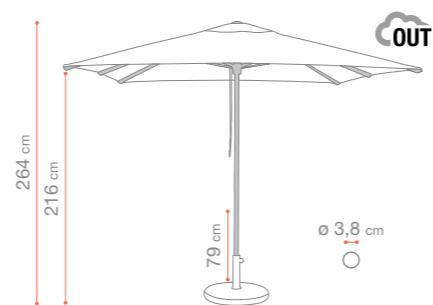

Aluminium - *Alluminio* - Aluminium

Polyester 250 g/m²

WINDMASTER

Parasol carré - *Ombrellone quadrato* - Eckiger Sonnenschirm
200 x 200 cm



recacril®
DESIGN LINE Acrylic 300 g/m²



Fiber glass ribs



Aluminium - *Alluminio* - Aluminium

SUNSET

Parasol carré - *Ombrellone quadrato* - Eckiger Sonnenschirm
200 x 200 cm

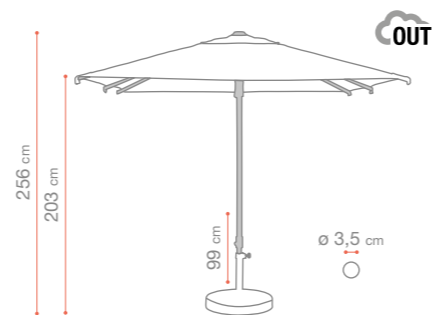

Aluminium - *Alluminio* - Aluminium

Olefin 200 g/m²



BASES PARASOL BASI PER OMBRELLONI SCHIRMSTÄNDER

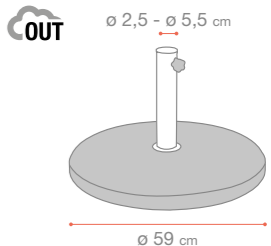
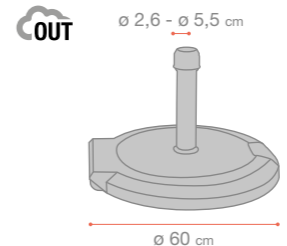
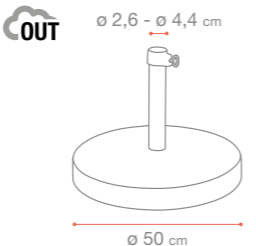

LES COLLECTIVITÉS
COLLETTIVITÀ
KOMMUNEN





DENVER & CAMPUS



CAMPUS*

Chaise - Sedia - Stuhl

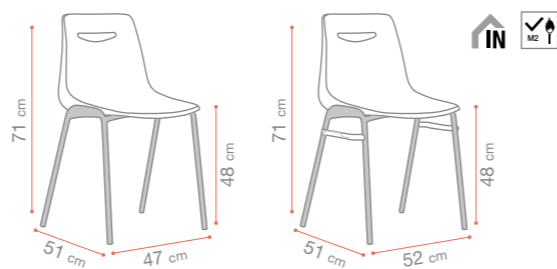

Acier - Acciaio - Stahl



Polypropylène - Polipropilene - Polypropylen



DENVER

Chaise - Sedia - Stuhl

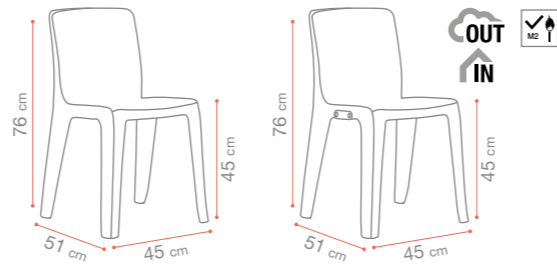

M2 & M4
Polypropylène - Polipropilene - Polypropylen



INDEX

LES COLLECTIVITÉS *COLLETTIVITÀ* KOMMUNEN

Autour du monde - *Intorno al mondo* - Rund um die Welt



INDEX
INDICE
INDEX



Produits conformes aux normes européennes EN 581-1, 581-2 et 581-3 :
produits testés en sécurité, résistance et stabilité pour un usage domestique et collectif.

Conforme alle norme europea EN 581-1/2/3 :
prodotto sottoposto a test di sicurezza, resistenza e stabilità per uso domestico e collettivo.

Entspricht den europäischen Normen EN 581-1 und 581-3:

Produkt auf Sicherheit, Festigkeit und Stabilität getestet, für den gewerblichen und privaten Einsatz.

Dimensions données à titre indicatif
Dimensioni indicate a titolo indicativo
Die angegebenen Abmessungen dienen als Anhaltspunkt



Produit à destination intérieure
Prodotto ad uso interno
Produkt für den Innenbereich

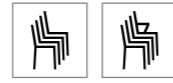

Empilable
Impilabile
Stapelbar



Produit à destination extérieure
Prodotto ad uso esterno
Produkt für den Außenbereich



Déhoussable
Sfoderabile
Abnehmbar



Tissu déperlant
Tessuti idrorepellenti
Wasserabweisende Stoffe

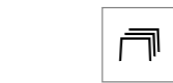

Positions réglables
Posizioni regolabili
Einstellbare Positionen



Lavage machine à 40°C
Lavare in lavatrice a 40 ° C
Maschinenwäsche bei 40 ° C



Nombre de places possibles
Numero di posti possibili
Anzahl der möglichen Plätze



Patins réglables
Piedini regolabili
Höhenverstellungen



Extensible
Allungabile
Ausziehbar



Rabattable
Ribaltabile
Klappbar



Encastrable
Sistemazione ad incastro
Bündig



Changement de toile en 5 min
Cambio di tela in 5 min
Bespannung in 5 Min zu wechseln

CHAISES & FAUTEUILS

SEDIE & POLTRONE - STÜHLE & SESSEL

RAMATUELLE 73'

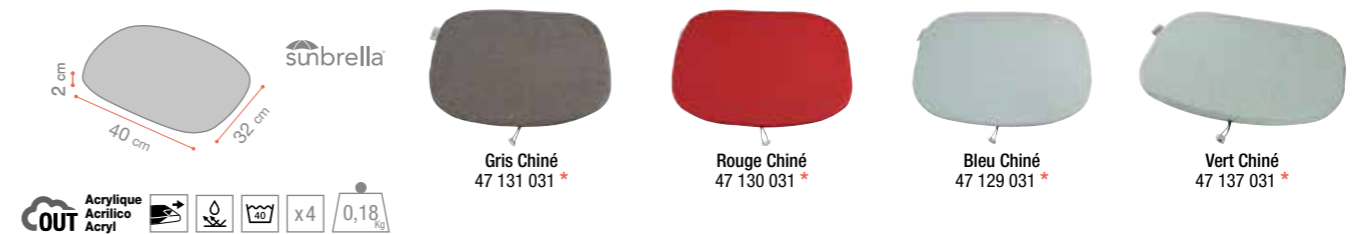

SUNSET CONFORT



SUNSET

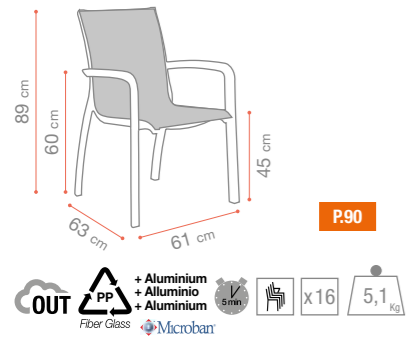

OUT **PP** + Aluminium + Aluminium + Aluminium
Fiber Glass **Microban**
x16 5,1 kg



Blanc Glacier
T28 Blanc 49 015 096
T33 Beige Chiné 49 027 096
T35 Turquoise Chiné 49 031 096
Gris Platinum
T30 Gris 49 021 289
T33 Beige Chiné 49 027 289



Noir Volcanique
T29 Noir 49 008 288
T30 Gris 49 021 288
T34 Gris Chiné 49 028 288
Bronze Fusion
T31 Cognac 49 026 599
T36 Brun Chiné 49 037 599

+ DURABLE - DUREVOLE
NACHHALTIG
+ RESPONSABLE
RESPONSABLE
VERANTWORTUNGSVOLL
Microban
x36 1,3 kg



T28 Blanc 43 012 096
T29 Noir 43 014 288
T30 Gris 43 015 289
T31 Cognac 43 013 599
T33 Beige Chiné 43 030 009
T34 Gris Chiné 43 031 288
T35 Turquoise Chiné 43 032 096
T36 Brun Chiné 43 033 003

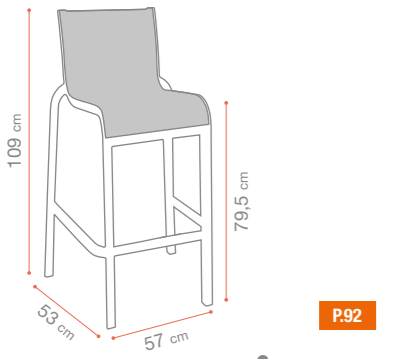

OUT **Aluminium** **Aluminium** **Aluminium**
Microban
x6 4,95 kg



Blanc Glacier
T28 Blanc 34 300 096
Gris Platinum
T30 Gris 34 301 289
Noir Volcanique
T34 Gris Chiné R8 401 288
Bronze Fusion
T31 Cognac 34 302 599

CANNES

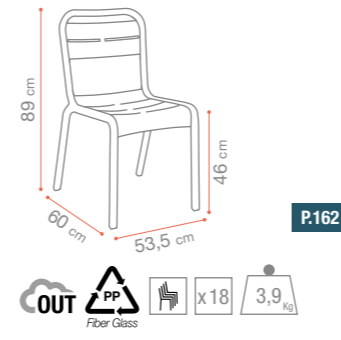

OUT **PP** **Fiber Glass**
x18 3,9 kg



Havane U2 801 011
Anthracite U2 801 002
Terracotta U2 801 814
Jaune Indien U2 801 737
Vert Tender U2 801 736
Bleu Minéral U2 801 784

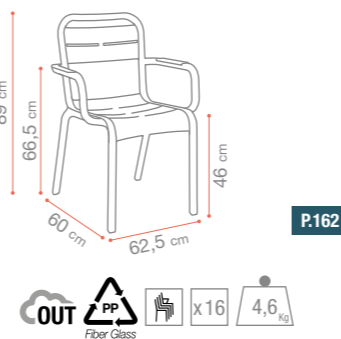

OUT **PP** **Fiber Glass**
x16 4,6 kg



Havane U2 901 011
Anthracite U2 901 002
Terracotta U2 901 814
Jaune Indien U2 901 737
Vert Tender U2 901 736
Bleu Minéral U2 901 784

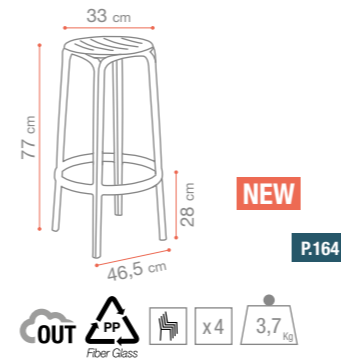

OUT **PP** **Fiber Glass**
x4 3,7 kg



Havane U6 101 011
Anthracite U6 101 002
Terracotta U6 101 814

ORONET 17



P.61
Nettoyant Textilène/PVC
textyle cleanser

47 039 031

MOON

VÉGÉTAL

SLAT NEW

TULIPE

FACTORY

SUNDAY

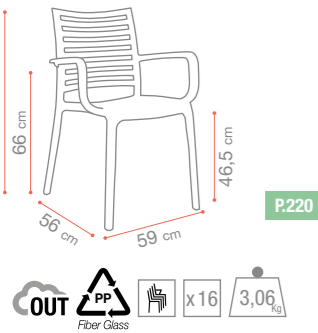
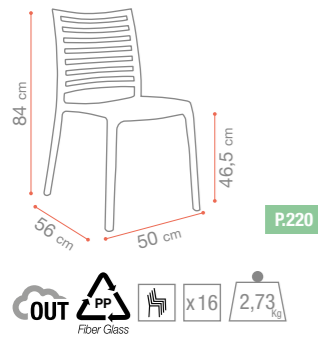

CLIP

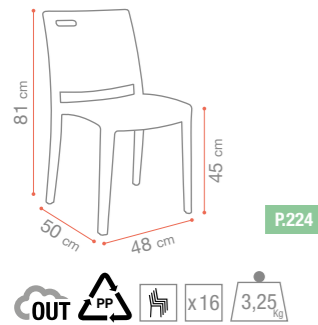

MILTON

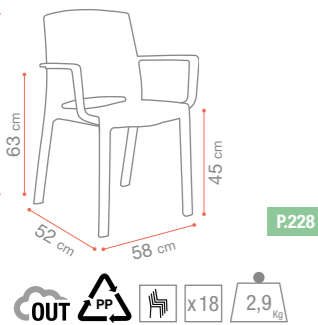

MIAMI BISTROT

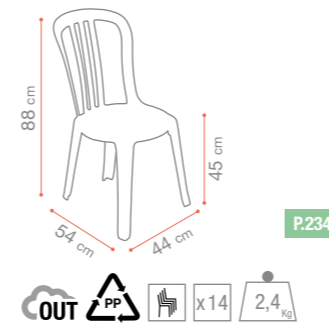

MIAMI PLIANTE

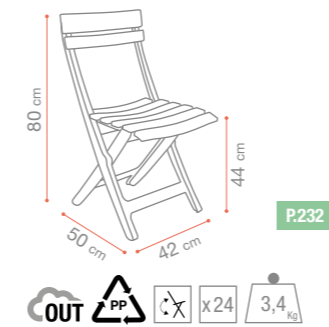

PALAO

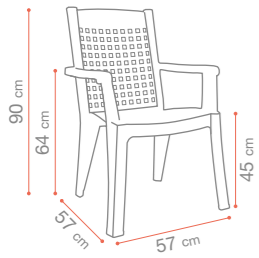

Anthracite
49 473 002



MIAMI CLUB

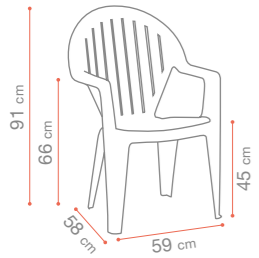

Blanc
49 504 004



Anthracite
49 504 002



Taupe
49 504 181



Vert Amazonie
04 601 078



MADRAS

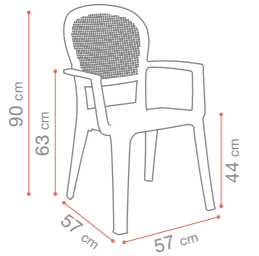

Blanc
46 131 904



Anthracite
01 601 002



Vert Amazonie
46 131 978



MIAMI

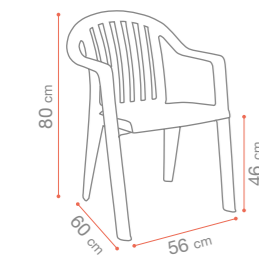

Blanc
49 023 004



Anthracite
00 501 002



Taupe
00 501 181



Vert Amazonie
49 023 078



DENVER

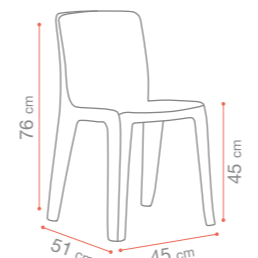

P.324



M2 Anthracite
33 600 002



M2 Bordeaux
33 600 027



M2 Beige
33 400 003



M2 Gris
33 600 009



M4 Beige
33 510 003

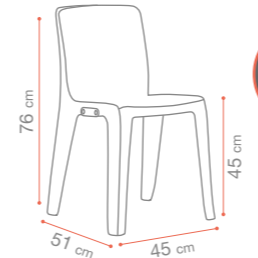

P.324



M2 Anthracite
39 201 002



M2 Bordeaux
39 201 027



M2 Beige
39 110 003



M2 Gris
39 201 009



Barre d'attache
73 221 131



Chariot
36 110 231

CAMPUS

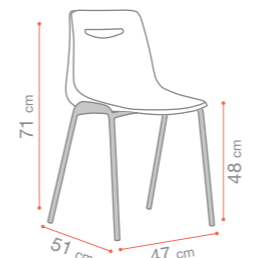

P.322



M2 Noir
33 850 017 *



M2 Rouge
33 850 202 *



M2 Beige
33 850 003 *



M2 Acajou
33 850 067 *



M2 Bleu
33 850 005 *

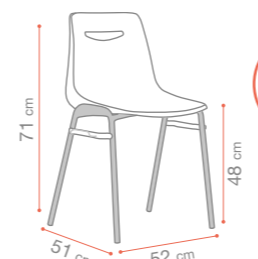

P.322



M2 Noir
39 850 017 *



M2 Rouge
39 850 202 *



M2 Beige
39 850 003 *



M2 Acajou
39 850 067 *



M2 Bleu
39 850 005 *



Barre d'attache
73 201 831 *

TABLES - TAVOLI - TISCHE

RAMATUELLE 73'

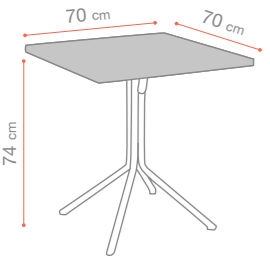

P.32



Crème Absolute
S7 501 710



Gris Pavement
S7 501 713

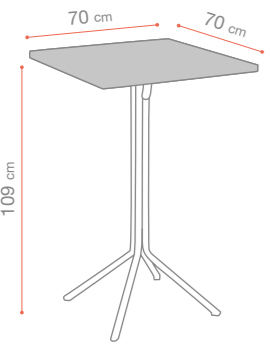

P.32



Crème Absolute
S7 601 710



Gris Pavement
S7 601 713 *

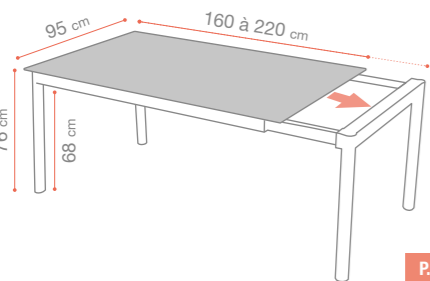
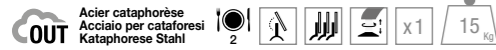

NEW

P.38



Gris Cryptic / Gris Pavement
S8 002 713



Brun Cryptic / Grège
S8 002 821

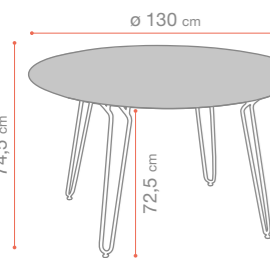

P.36



Naturale / Crème Absolute
52 364 710



Naturale / Bleu Ether
52 364 711



Nero / Rouge Bossa Nova
52 364 712



Nero / Gris Pavement
52 364 713



SUNSET

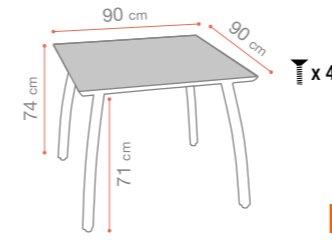

P.74



Blanc - Blanc Glacier
R4 101 096 + 55 729 096



Gris Cryptic - Gris Platinium
R4 101 788 + 55 729 289



Gris Cryptic- Noir Volcanique
R4 101 788 + 55 729 288



Brun Cryptic + Bronze Fusion
R4 101 789 + 55 729 599

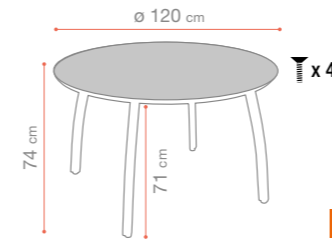
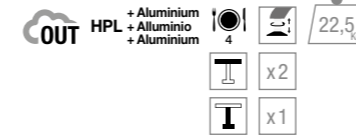

P.72



Blanc - Blanc Glacier
R5 001 096 + 55 734 096



Gris Cryptic - Gris Platinium
R5 001 788 + 55 734 289



Gris Cryptic- Noir Volcanique
R5 001 788 + 55 734 288



Brun Cryptic + Bronze Fusion
R5 001 789 + 55 734 599

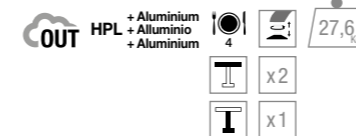

CANNES

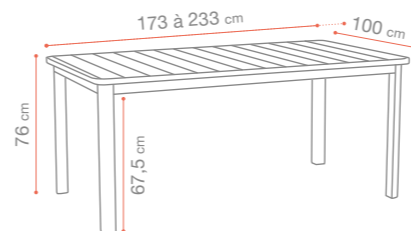

P.172



Anthracite
U3 801 002



Havane
U3 801 011



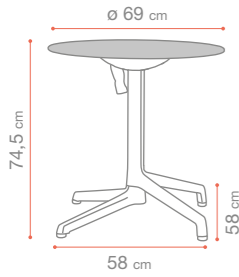

P.168

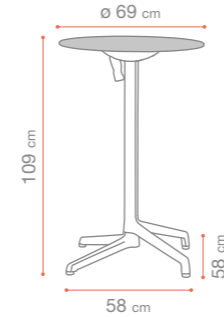
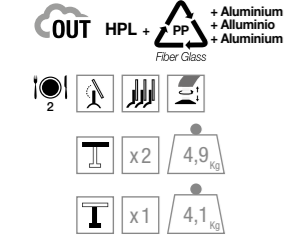

P.168

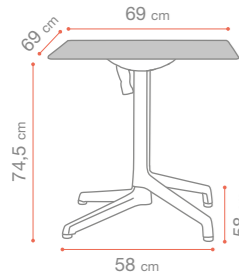
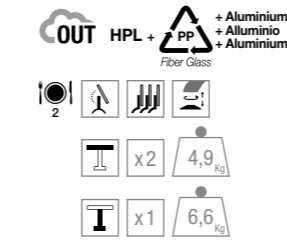

P.168

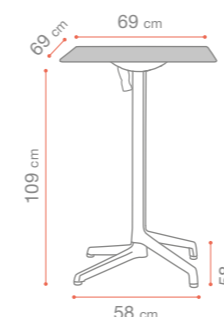
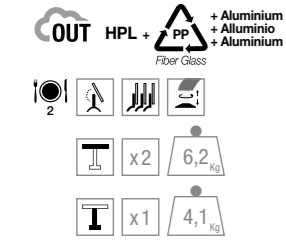

P.168

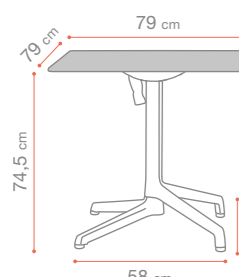
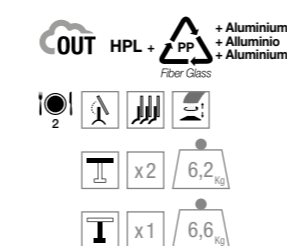

P.168

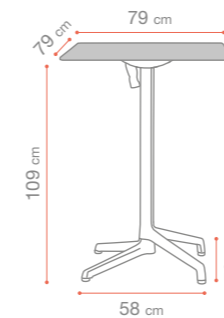
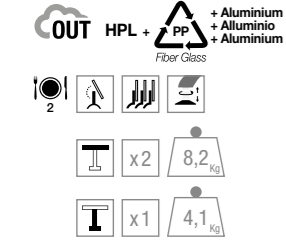

P.168

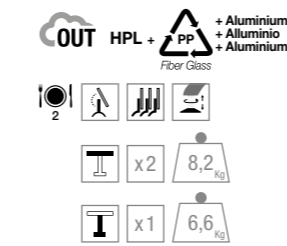

CANNES NEW

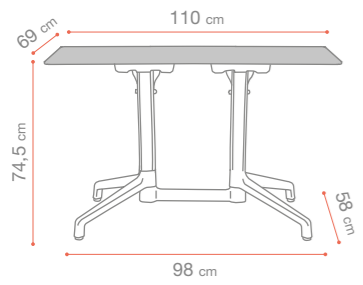

Anthracite - Gris Cryptic
U4 101 002 + U5 101 788



Anthracite - Walnut
U4 101 002 + U5 101 722



Havane - Gris Cryptic
U4 101 011 + U5 101 788



Terracotta - Gris Cryptic
U4 101 814 + U5 101 788



Terracotta - Walnut
U4 101 814 + U5 101 722



Havane - Walnut
U4 101 011 + U5 101 722

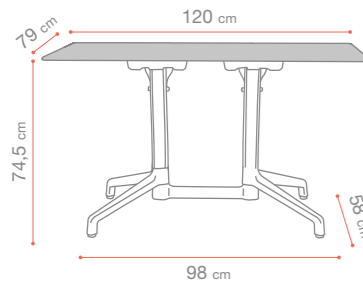
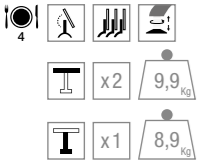

Anthracite - Gris Cryptic
U4 101 002 + U5 201 788



Anthracite - Walnut
U4 101 002 + U5 201 722



Havane - Gris Cryptic
U4 101 011 + U5 201 788



Terracotta - Gris Cryptic
U4 101 814 + U5 201 788



Terracotta - Walnut
U4 101 814 + U5 201 722



Havane - Walnut
U4 101 011 + U5 201 722

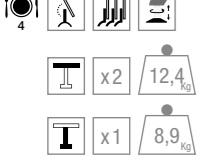

GREGGIA

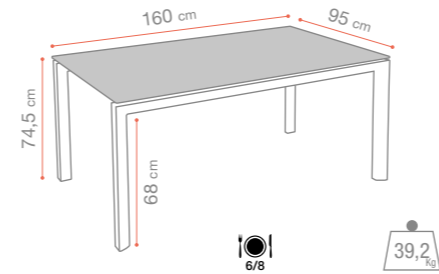

Gris Platinum 160
S7 301 289

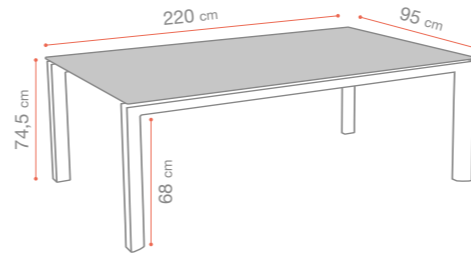

Gris Platinum 220
S7 401 289



ALPHA

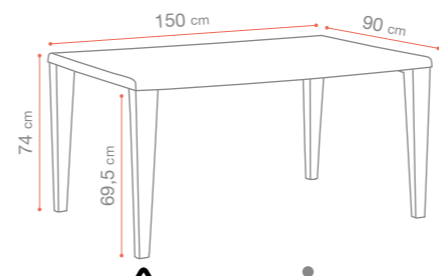

Blanc Glacier
52 352 096



Anthracite
52 352 002



Lin
52 352 581



MIAMI*

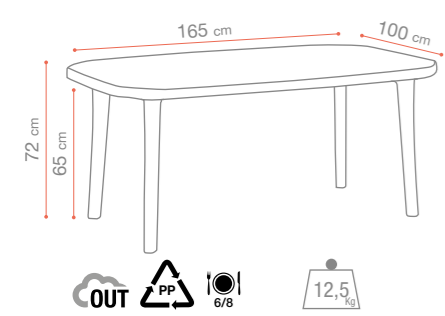

Blanc
52 260 004 *



Vert Amazonie
52 260 078 *



Taupe
52 072 181 *

x1

x6



TABLE ECOFIX



P.248



Blanc
56 000 004



Anthracite
56 000 002



Taupe
56 000 181

PALMA

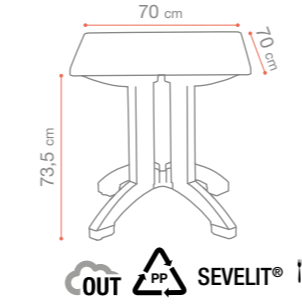

Anthracite
56 951 002

VEGA

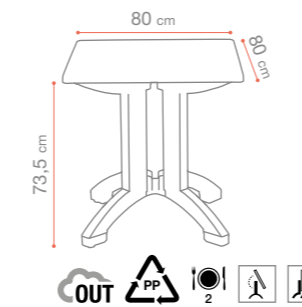

Anthracite
23 401 002 *

SUN

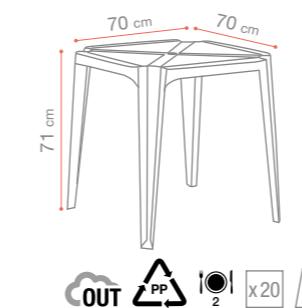

Blanc
55 902 004



Anthracite
55 902 002



Taupe
55 902 181



Vert Amazonie
55 902 078

PIEDS - BASAMENTI - GESTELLE

X2.O **NEW**



OUT + Aluminium + Aluminium + Aluminium x1 4,1 kg Plateaux 70x70 Ø 70 Piani tavoli 80x80 Ø 80 Platten



OUT + Aluminium + Aluminium + Aluminium x1 6,6 kg Plateaux 70x70 Ø 70 Piani tavoli 80x80 Ø 80 Platten



OUT + Aluminium + Aluminium + Aluminium x1 8,9 kg Plateaux 110x70 Piani tavoli 120x80 Platten



XONE



OUT + Aluminium + Aluminium + Aluminium x1 7,5 kg Plateaux 60x60 Ø 60 Piani tavoli 70x70 Ø 70 Platten 80x80 Ø 80



OUT + Aluminium + Aluminium + Aluminium x1 7,6 kg Plateaux 80x80 Ø 80 Piani tavoli 90x90 Ø 90 Platten



OUT + Aluminium + Aluminium + Aluminium x1 8,7 kg Plateaux 60x60 Ø 60 Piani tavoli 70x70 Ø 70 Platten 80x80 Ø 80



OUT + Aluminium + Aluminium + Aluminium x1 14 kg Plateaux 110x70 Piani tavoli 120x80 Platten

QUATTRO NEW



P.240
 + Aluminium
 + Alluminio
 + Aluminium
 Fiber Glass
 x1
 5,2 kg
 Plateaux 60x60 Ø 60
 Piani tavoli 70x70 Ø 70
 Platten 80x80 Ø 80



P.240
 + Aluminium
 + Alluminio
 + Aluminium
 Fiber Glass
 x1
 5,8 kg
 Plateaux 60x60 Ø 60
 Piani tavoli 70x70 Ø 70
 Platten 80x80 Ø 80

TETRA INOX

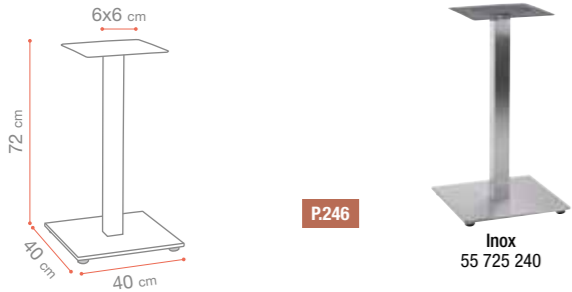

P.246
 IN
 OUT Inox
 x1
 17,5 kg
 Plateaux 70x70 Ø 70
 Piani tavoli 80x80 Ø 80
 Platten

DOMOS



P.246
 IN
 OUT Acier cataphorèse
 Acciaio per catanofresi
 Kataphorèse Stahl
 x1
 20 kg
 Plateaux 70x70 Ø 70
 Piani tavoli 80x80 Ø 80
 Platten

ECOFIX



P.248
 IN
 OUT Aluminium
 Alluminio
 Aluminium
 x1
 7,6 kg
 Plateaux 70x70 Ø 70
 Piani tavoli 80x80 Ø 80
 Platten



P.248
 IN
 OUT Aluminium
 Alluminio
 Aluminium
 x1
 8,8 kg
 Plateaux 110x70
 Piani tavoli 120x80
 Platten

	OUT						IN				
	PLATEAUX HPL (RAILS) / HPL TABLE TOPS (RAILS)						EXTERIOLIT (RAILS)		COLOR TOP	LAMIDUR	
	Ø60	60x70	69x69	80x80	110x69	120x80	68x68	80x80	70x70	68x68	80x80
X2.0		•	•	•			•	•	•	•	•
X2.0 HAUT		•	•	•			•	•	•	•	•
X2.0 DOUBLE					•	•					
XONE	•	•	•	•			•	•	•	•	•
XONE XL				•				•			•
XONE HAUT	•	•	•	•			•	•	•	•	•
XONE DOUBLE					•	•					
QUATTRO	•	•	•	•			•	•	•	•	•
QUATTRO HAUT	•	•	•	•			•	•	•	•	•
ECOFIX SIMPLE	•	•	•	•			•	•	•	•	•
ECOFIX DOUBLE					•	•					
TETRA	•	•	•	•			•	•	•	•	•
DOMOS	•	•	•	•			•	•	•	•	•

PLATEAUX - PIANI TAVOLI - PLATTEN

PLATEAUX HPL (RAILS) - HPL TABLE TOPS (RAILS)



	BLANC TOUCH * Cœur Noir Anima nera Schwarzer Kern	NATURAL TOUCH Cœur Brun Anima marrone Brauner Kern	WALNUT TOUCH Cœur Brun Anima marrone Brauner Kern	SWEDEN TOUCH * Cœur Brun Anima marrone Brauner Kern	VULCANO TOUCH Cœur Noir Anima nera Schwarzer Kern	BÉTON TOUCH Cœur Noir Anima nera Schwarzer Kern	MARBRE KANDIA * Cœur Noir Anima nera Schwarzer Kern
ø 60 cm	56 345 004	56 979 723	56 979 722	56 345 076	56 979 051	56 979 174	-
60 x 70 cm	56 977 004	56 961 723	-	-	56 961 051	56 961 174	-
70 x 70 cm 69 x 69 cm	56 940 004 17 101 004	56 962 723 17 101 723	- -	56 940 076 17 101 076	- 17 101 051	- 17 101 174	- 17 101 790
80 x 80 cm	56 950 004	56 978 723	56 978 722	56 950 076	56 978 051	56 978 174	56 978 790
110 x 70 cm 110 x 69 cm	56 957 004 -	56 958 723 -	56 958 722 -	56 957 076 27 701 076	- 27 701 051	56 958 174 27 701 174	56 958 790 -
120 x 80 cm	56 887 004	56 959 723	56 959 722	56 887 076	56 959 051	-	56 959 790

COLOR TOP



	Apache U2 601 786	Gypsy Rouge U2 601 774	Jungle Wood Full U2 601 771	Jungle Wood U2 601 785	Zébrure Noir U2 601 775
70 cm					
Bois Naturel U2 601 777					
Bois Oxydé U2 601 787					
Patchwork U2 601 772					
Marbre U2 601 773					
Mesh Concrete Bronze U2 601 776					

PLATEAUX HPL CANNES (INSERTS) - CANNES HPL TABLE TOPS (INSERTS)



COMPATIBLE X-ONE & X2 ONLY

	WALNUT TOUCH Cœur Brun Anima marrone Brauner Kern	GRIS CRYPTIC Cœur Noir Anima nera Schwarzer Kern
ø 69 cm	U5 301 722	U5 301 788
69 x 69 cm	U4 901 722	U4 901 788
79 x 79 cm	U5 001 722	U5 001 788
69 x 110 cm	U5 101 722	U5 101 788
120 x 79 cm	U5 201 722	U5 201 788

EXTERIOLIT



	Gris Béton S8 401 247	Chêne Clair S8 501 088	Gris Béton S8 501 247
68 cm			
80 cm			

LAMIDUR



	Jurassic S7 801 738	Chêne Clair S7 801 739	Jurassic S7 901 738	Chêne Clair S7 901 739
68 cm				
80 cm				

BAIN DE SOLEIL - SUNLOUNGERS

SUNSET GREEN EDITION **NEW**

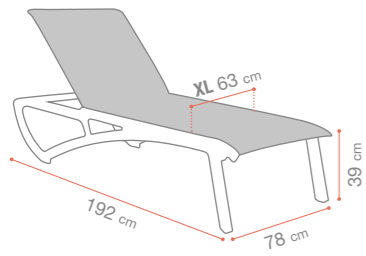

P.64



Lichen / T50 Coton
Q8 601 852



+ DURABLE - DUREVOLE
NACHHALTIG
+ RESPONSABLE - RESPONSABILE
VERANTWORTUNGSVOLL



x8 6,5 kg

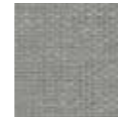

Toile T50 Coton
R5 702 852

SUNSET

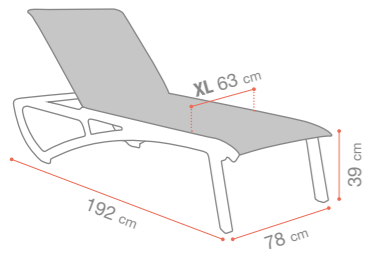

P.98



Gris Platinum / T30 Gris
47 034 289



Gris Platinum / T33 Beige Chiné
47 045 289



Bronze Fusion / T31 Cognac
47 035 599



Bronze Fusion / T36 Brun Chiné
47 049 599



Blanc Glacier / T28 Blanc
47 033 096



Blanc Glacier / T33 Beige Chiné
47 044 096



+ DURABLE - DUREVOLE
NACHHALTIG
+ RESPONSABLE - RESPONSABILE
VERANTWORTUNGSVOLL



Blanc Glacier / T35 Turquoise chiné
47 048 096



Blanc Glacier / T41 Bleu Madras
Q8 604 096



Noir Volcanique / T30 Gris
47 034 288



Noir Volcanique / T34 Gris Chiné
47 047 288

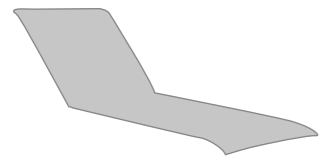

Microban

x8 6,5 kg

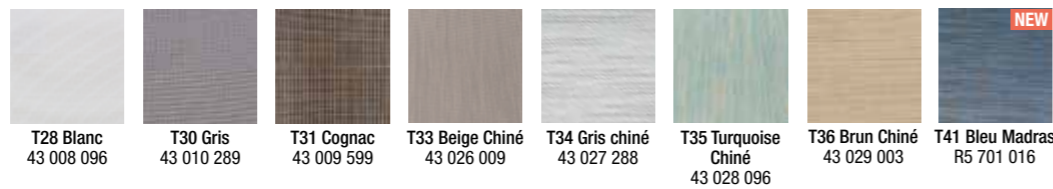

SUNSET CONFORT

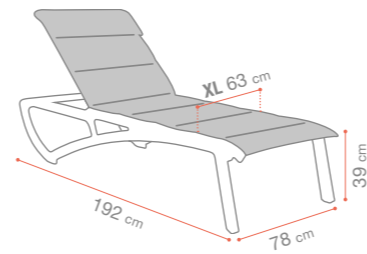

P.78



Blanc Glacier / T33 Beige Chiné
R3 701 096



Blanc Glacier / T41 Bleu Madras
R3 707 096

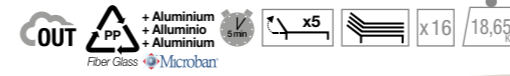

Gris Platinum / T33 Beige Chiné
R3 702 289



Bronze Fusion / T36 Brun Chiné
R3 703 599



Noir Volcanique / T34 Gris Chiné
R3 706 288

+ DURABLE - DUREVOLE
NACHHALTIG
+ RESPONSABLE - RESPONSABILE
VERANTWORTUNGSVOLL

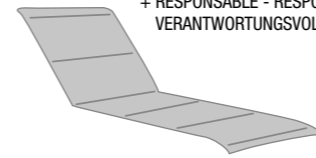

Microban

x12 6,5 kg



SUNSET & SUNSET CONFORT

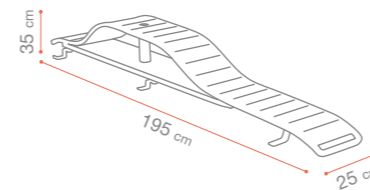

P.100



Blanc Glacier
53 005 096



Gris Platinum
53 005 289



Noir Volcanique
53 005 288*



Bronze Fusion
53 005 599

OUT Aluminium Aluminium Aluminium

x1 7 kg

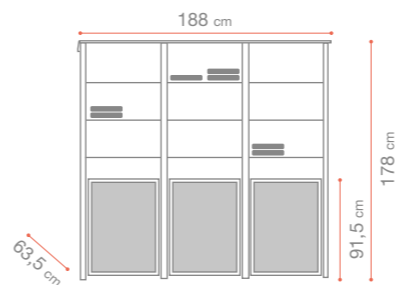

P.116



Gris Platinum / T30 Gris
U1 201 289



Bronze Fusion / T36 Brun Chiné
U1 201 599



Panière
U3 101 017

OUT Aluminium Aluminium Aluminium

x1 73 kg

x1 4,7 kg

BALI CONFORT



BALI



JAMAÏCA BEACH



MIAMI



ORONET 17



REPOS - RIPOSO - ENTSPANNUNG

CANNES **NEW**

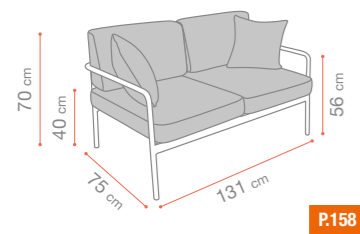

P.158



Havane / Gris Chiné
U6 901 011

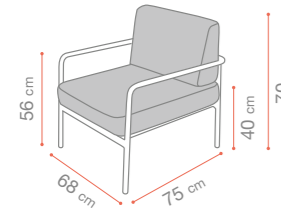

Terracotta / Gris Chiné
U6 901 814

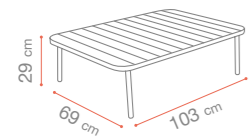

YÉYÉ 72'

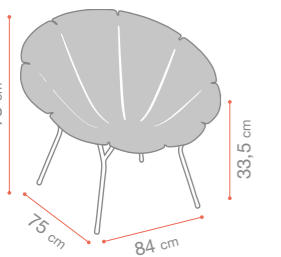

P.50



Blanc
49 178 004 *

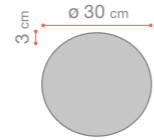

sunbrella



Jaune Chiné
47 132 031 *



SUNSET & SUNSET CONFORT



x1 0,9 kg



Blanc Glacier
CT 416 096



Gris Platinum
CT 416 289



Noir Volcanique
CT 416 288



Bronze Fusion
CT 416 599

SUNSET CONFORT

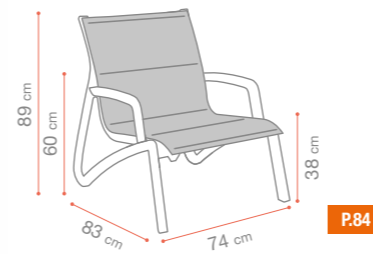

P.84



Blanc Glacier / T33 Beige Chiné
U2 402 096



Gris Platinum / T33 Beige Chiné
U2 402 289



Noir Volcanique / T34 Gris Chiné
U2 401 288



Bronze Fusion / T36 Brun Chiné
U2 403 599

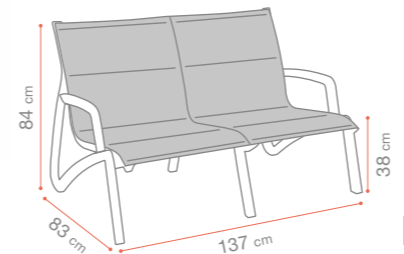

P.86



Blanc Glacier / T33 Beige Chiné
U2 502 096



Gris Platinum / T33 Beige Chiné
U2 502 289



Noir Volcanique / T34 Gris Chiné
U2 501 288



Bronze Fusion / T36 Brun Chiné
U2 503 599

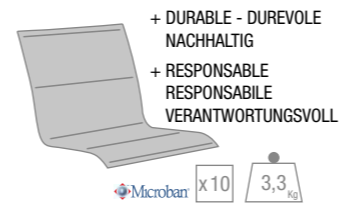

T33 Beige Chiné U4 401 009
T34 Gris Chiné U4 402 288
T36 Brun Chiné U4 403 003

SUNSET

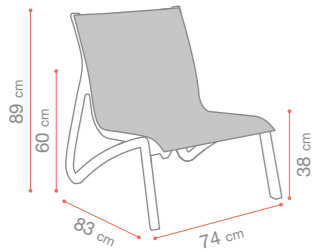

P.104



Blanc Glacier / T28 Blanc
58 002 096



Blanc Glacier / T33 Beige Chiné
58 007 096



Blanc Glacier / T35 Turquoise Chiné
58 008 096



Gris Platiniun / T30 Gris
58 002 289



Gris Platiniun / T33 Beige Chiné
58 007 289



Noir Volcanique / T30 Gris
58 003 288



Noir Volcanique / T34 Gris Chiné
58 009 288



Bronze Fusion / T31 Cognac
58 002 599



Bronze Fusion / T36 Brun Chiné
58 010 599

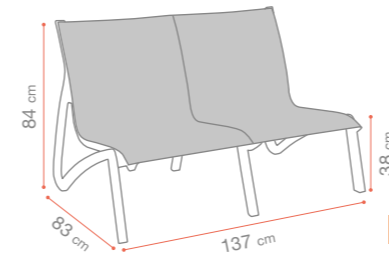

P.106



Blanc Glacier / T28 Blanc
58 001 096



Blanc Glacier / T33 Beige Chiné
R4 501 096



Blanc Glacier / T35 Turquoise Chiné
R4 502 096



Gris Platiniun / T30 Gris
58 001 289



Gris Platiniun / T33 Beige Chiné
R4 501 289



Noir Volcanique / T30 Gris
58 004 288



Noir Volcanique / T34 Gris Chiné
R4 503 288



Bronze Fusion / T31 Cognac
58 001 599



Bronze Fusion / T36 Brun Chiné
R4 504 599

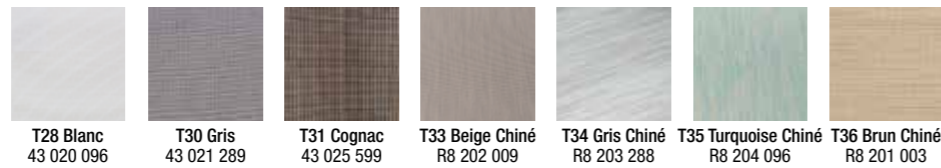
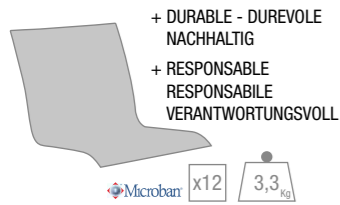

SUNSET



P.110



Blanc Glacier / T28 Blanc
R7 705 096



Blanc Glacier / T33 Beige Chiné
R7 709 096 *



Blanc Glacier / T35 Turquoise Chiné
R7 707 096 *



Bronze Fusion / T36 Brun Chiné
R7 708 599



Gris Platiniu / T30 Gris
R7 706 289



Gris Platiniu / T33 Beige Chiné
R7 709 289



Noir Volcanique / T30 Gris
R7 706 288



Noir Volcanique / T34 Gris Chiné
R7 710 288



T28 Blanc
43 022 096



T30 Gris
43 023 289



T33 Beige Chiné
R8 104 009



T35 Turquoise Chiné
R8 102 096



T36 Brun Chiné
R8 101 003



T34 Gris Chiné
R8 103 288

SUNSET & SUNSET CONFORT

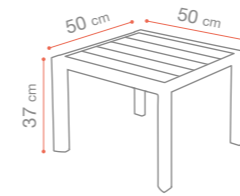

P.114

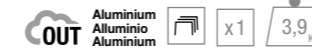

Blanc Glacier
53 010 096



Gris Platiniu
53 010 289



Noir Volcanique
53 010 288



Bronze Fusion
53 010 599



Vert Lichen
R5 301 852

NEW

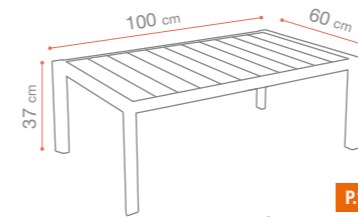

P.114



Blanc Glacier
53 004 096



Gris Platiniu
53 004 289



Noir Volcanique
53 004 288



Bronze Fusion
53 004 599

WESTPORT

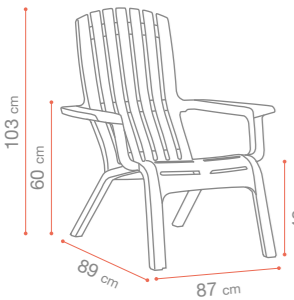

P.190



Blanc
U2 701 004



Taupe
U2 701 181



ORONET 17



P.61

Nettoyant Textilène/PVC
textyle cleanser

47 039 031

MIAMI

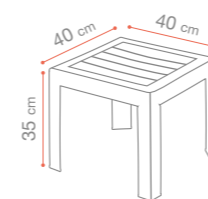

P.295



Blanc
ML 756 004



Anthracite
ML 756 002



Lin
ML 756 581



Taupe
ML 756 181



Vert Amazonie
ML 756 078



Bois
ML 756 008



Vert Tender
ML 756 736



Jaune Indien
ML 756 737



Rouge Bossa Nova
ML 756 712



Forest Green
23 001 818

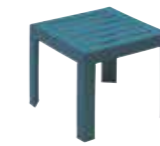

Bleu Minéral
23 001 784

PARASOLS - OMBRELLONI SONNENSCHIRME

GREENWICH

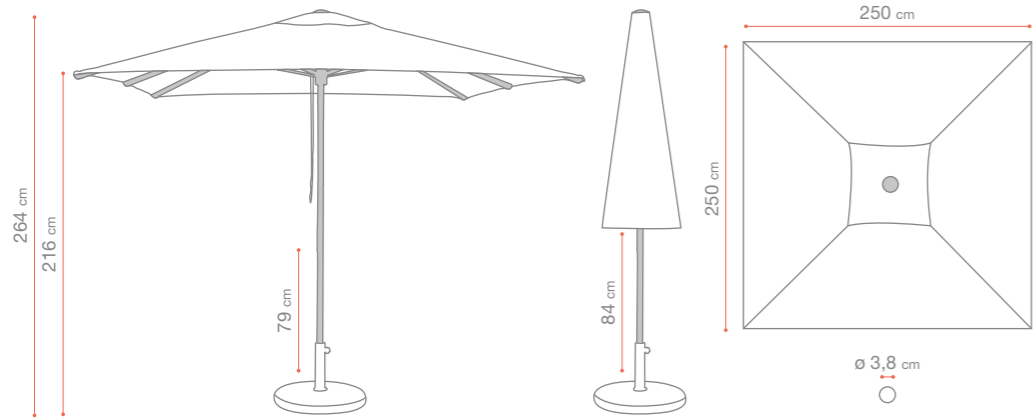

Toile 100% polyester teinté masse 250 g/m²
 Fibra 100% Poliestere tinta in massa 250 g/m²
 100% durchgefärbtes Polyester 250 g/m²



Blanc
U4 601 096



Beige
U4 601 003

WINDMASTER



Toile 100% acrylica teinté masse 300 g/m²
 Fibra 100% Acrilica tinta in massa 300 g/m²
 100% durchgefärbtes Acryl 300 g/m²



Blanc
U4 501 096



Beige
U4 501 003



Gris
U4 501 235

SUNSET

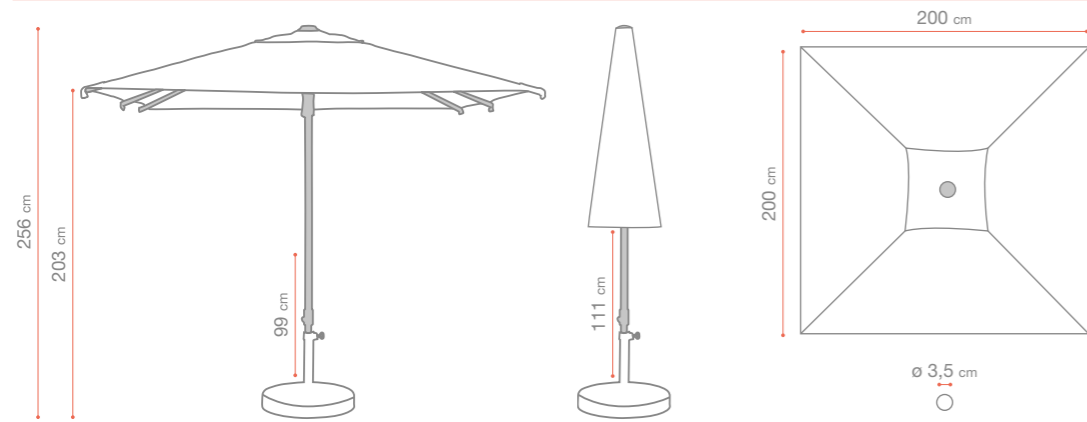

Toile 100% Olefin teinté masse 200 g/m²
 Fibra 100% Olefina tinta in massa 200 g/m²
 100% durchgefärbtes Olefin 200 g/m²



BASES PARASOL - BASI PER OMBRELLONI - SCHIRMSTÄNDER

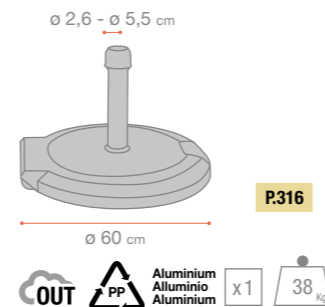
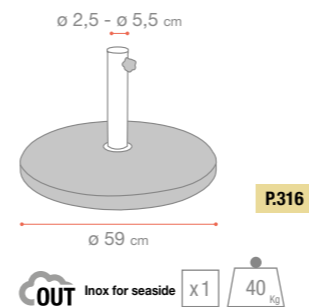
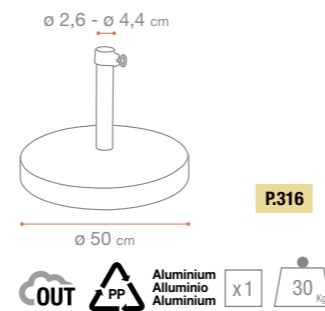

HOUSSÉ PARASOL - COPERTURA - SONNENSCHIRM-HÜLLE

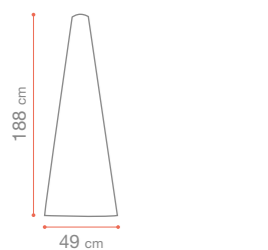

Housse universelle polyester
 U4 801 017



FRANCE

Grosfillex S.A.S
Rue de Lac
CS 60401 Arbent
01117 Oyonnax Cedex
Tél. : 00 33 (0) 4 74 73 30 30
Fax : 00 33 (0) 4 74 73 32 30
advfrance@grosfillex.com

EXPORT DEPARTMENT

Tél. : 00 33 (0) 4 74 73 30 53
Fax : 00 33 (0) 4 74 73 32 30
export@grosfillex.com

GROSFILLEX UK

Peek House
20 Eastcheap
EC3M 1EB
London
United Kingdom
Tél. : 00 44 (0) 2 077 238 389
Fax : 00 44 (0) 2 077 883 408
grosfillexuk@grosfillex.com

ESPAÑA - PORTUGAL CARIBE AMERICA CENTRAL AMERICA DEL SUR

City Park
Carretera de Hospitalet, 147-149
Edificio Berlin
08940 Cornellá de Llobregat
Barcelona
Tél. : 00 34 93 474 01 19
Fax : 00 34 93 474 54 10
espana@grosfillex.com

ITALIA

Sede Legale: Via Fieno 3
20123 Milano
Tél. : 0039 02 38 23 07 91
Tél. : 0039 03 21 53 93 11
italia@grosfillex.com

DEUTSCHLAND, ÖSTERREICH, OSTEUROPA

Grosfillex GmbH
Rheinstr. 96/F1
D-56235 Ransbach-Baumbach
Tel.: 00 49 2623 606 476 0
Fax : 00 49 2623 606 476 66
deutschland@grosfillex.com

BENELUX

Loopkantstraat 25
5405 AC Uden
Nederland
Tel: 00 31 (0) 413 247 145
Tel: 00 32 (0) 69 89 00 24
nederland@grosfillex.com
email-belux@grosfillex.com

SUISSE SCHWEIZ SVIZZERA

Case postale 30
Chemin de la Combe 4
1297 Founex (VD)
Tél. : 00 41 22 960 98 10
Fax : 00 41 22 776 44 29
switzerland@grosfillex.com



www.grosfillex-expert.com